



SINFONES



Sinfón /fr/

fr

FR
DISCRIMINACIÓN AUDITIVA: TACHAR, COLOREAR,...LOS DIBUJOS QUE LLEVAN O QUE NO LLEVAN EL SONIDO
DISCRIMINACIÓN AUDITIVA: SE ESCRIBEN SINFONES Y TIENEN QUE TACHAR, COLOREAR,... LOS SINFONES QUE HAN OÍDO
DISCRIMINACIÓN AUDITIVA: SE ESCRIBE MEZCLA DE SINFONES Y SÍLABAS MIXTAS, TIENEN QUE TACHAR, COLOREAR,... LOS SINFONES QUE HAN OÍDO
DISCRIMINACIÓN VISUAL: LEER, RECORTAR Y PEGAR CADA SINFÓN CON SU CORRESPONDIENTE.
DISCRIMINACIÓN VISUAL: LEER, RECORTAR Y PEGAR CADA SINFÓN Y SÍLABAS MIXTAS CON SU CORRESPONDIENTE.
SE REALIZA UN DIBUJO, SE DIVIDE EN TROCITOS Y EN ELLOS SE ESCRIBE UN SINFÓN O SÍLABA MIXTA. DESPUÉS SE PONE LAS CLAVES PARA EL COLOREADO.
UNIR PALABRAS CON DIBUJO
IDENTIFICAR UN SINFÓN DENTRO DE LAS PALABRAS DE UNA FRASE O TEXTO Y LUEGO SE COPIA.
COMPLETAR PALABRAS QUE LLEVEN LA IMAGEN PARA IDENTIFICARLAS
UNIR SÍLABAS PARA FORMAR PALABRAS
ESCRIBIR EL NOMBRE DE LAS IMÁGENES
DAR UNA IMAGEN Y ESCRIBIR UNA FRASE
COMPLETAR FRASES A PARTIR DE UNAS PALABRAS DADAS
COMPLETAR FRASES CON AYUDA DE IMAGEN DEL SINFÓN
COMPRESIÓN DE FRASES: DIBUJAR LO QUE HAS LEÍDO
COMPLETAR CON SINFÓN O SÍLABA MIXTA LAS PALABRAS DE UNA FRASE O TEXTO
ORDENAR PALABRAS PARA FORMAR FRASES CON SENTIDO
ESCRIBIR PALABRAS QUE LLEVEN SINFÓN Y SÍLABA MIXTA
SOPA DE LETRAS
CRUCIGRAMA
ADIVINANZAS



Colorea los dibujos donde suene «fr»:

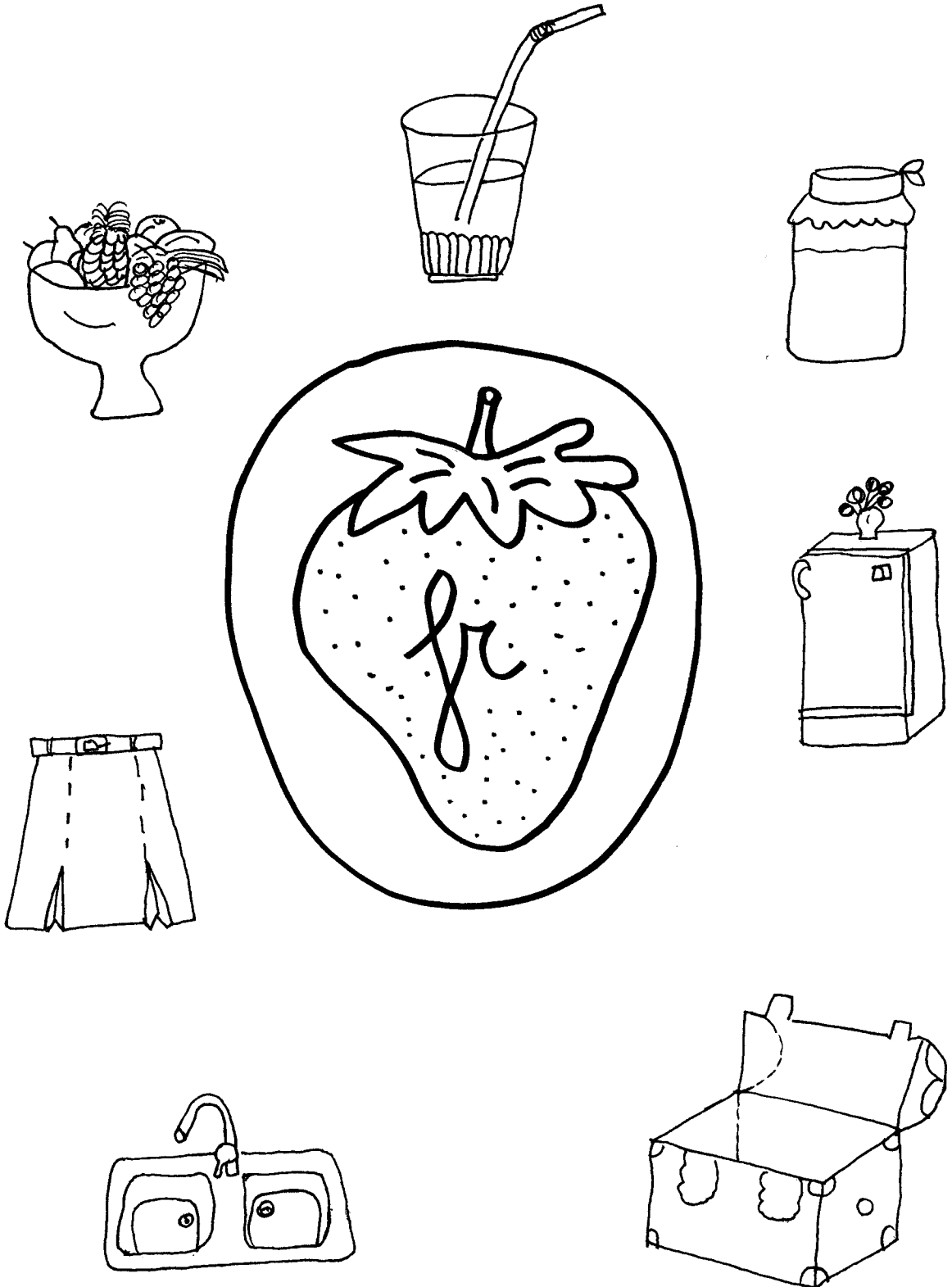



Tacha lo que sigas:

-fra- de color rojo; -fro- de color verde;
 -fru- de color azul; -fri- de color ama-
 rillo; y -fre- de color rosa.

fra

fro

fri

fra

fru

fre

fro

fre

fri

fro

fra

fru

fro

fru

fri

fre



Rodea lo que sigas:

-fra- de color azul; -fro- de color rojo;
-fru- de color marrón; -fri- de color
rosa; y -fre- de color verde.

fra fru fir for fri fra

fro fre fur fir far fro

fur fra fru fer for fir

fre fru fir fro far fre

fer for fri fre fer fur



fra	fri	fro	fru	fre
fro	fre	fra	fri	fru
fri	fra	fru	fre	fro
fre	fru	fri	fra	fra
fru	fri	fra	fro	fri

Recorta, busca y pega en el cuadro superior donde le corresponda.

fru	fri	fra	fro	fri
fra	fri	fro	fru	fre
fri	fra	fru	fre	fro
fro	fre	fra	fri	fru
fre	fru	fri	fra	fra



fir	far	fru	fur	fra
fra	fur	fru	fra	fir
fra	far	fir	fro	for
for	fro	fri	fer	fra
fir	far	fru	for	fra

Recorta, busca y pega en el cuadro superior donde corresponda.

fir	far	fru	for	fra
fra	far	fir	fro	for
fir	far	fru	fur	fra
fra	fur	fru	fra	fir
for	fro	fri	fer	fra



Colorea donde veas «fra», «fre», «fri», «fro», «fru»:

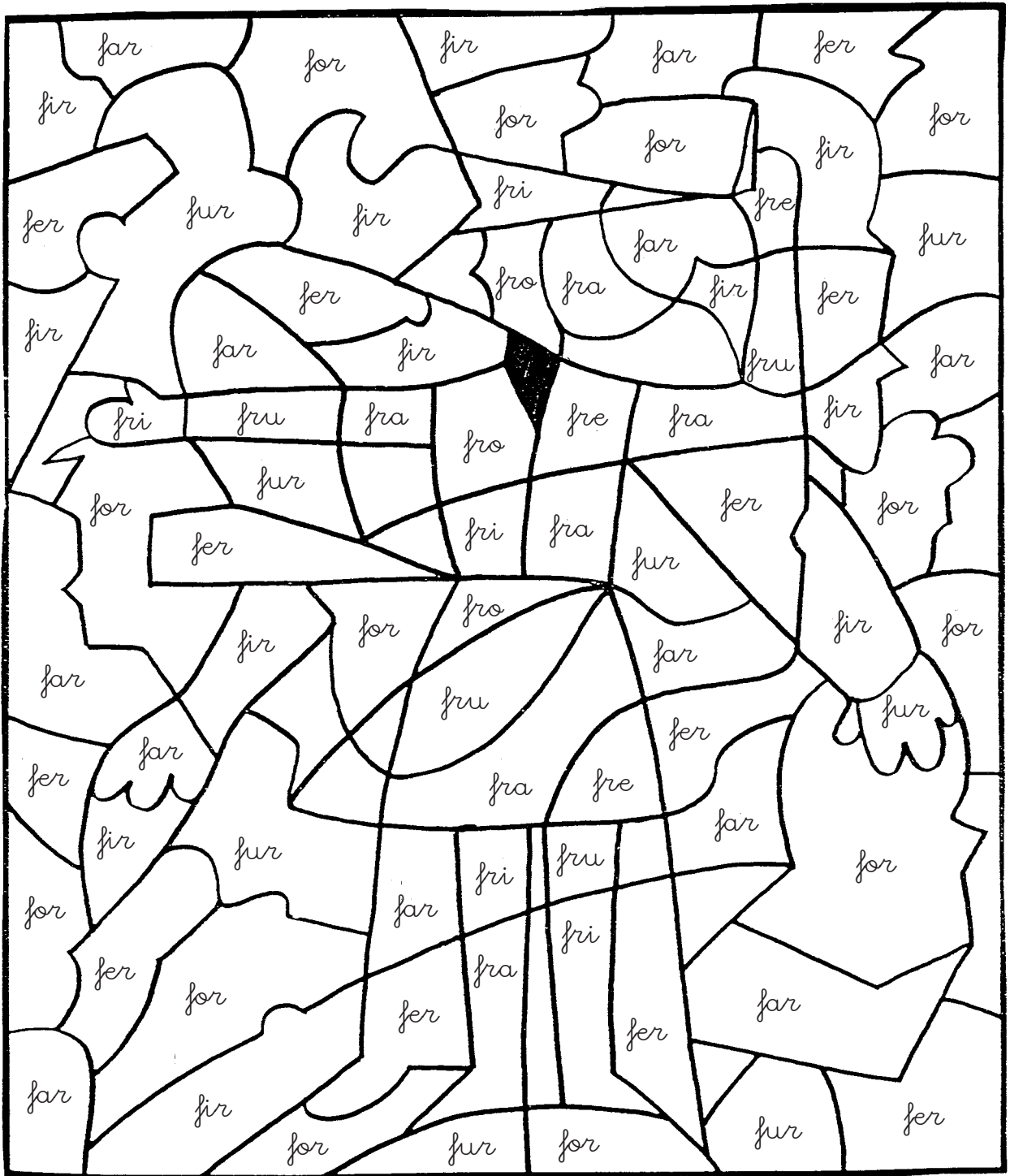



Une cada palabra con su dibujo:

refresco

cafè

fregadero

fruta

Francisca

fresa

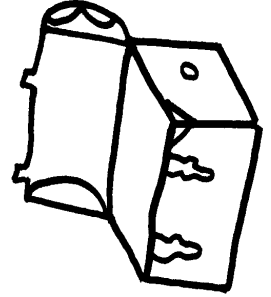
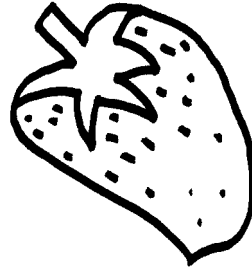
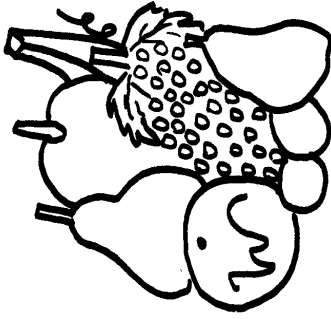
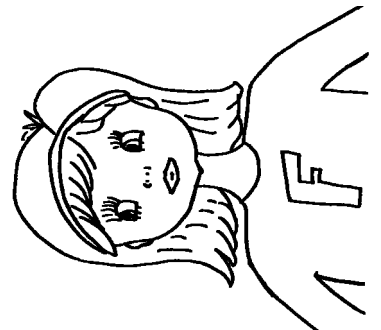
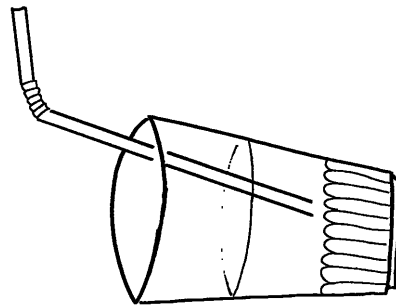
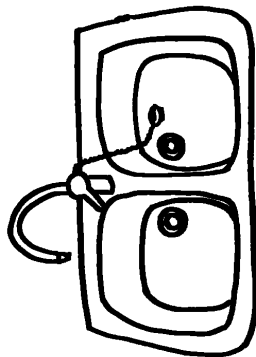



Subraya las palabras que lleven «fr» y cópialas.

El frutero envió varias cajas de fruta fresca a Francia. El camión frenó al llegar frente a la frontera. Los frutos que llevaba eran variados: fresas, sandías, fresones y frambuesas. Algunos de estos frutos se mantienen fresquitos en el frigorífico que lleva el camión.



Completa las siguientes palabras:

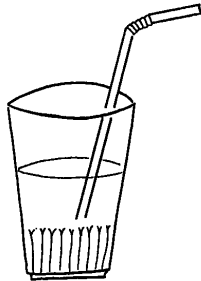

re _ _ _ sco

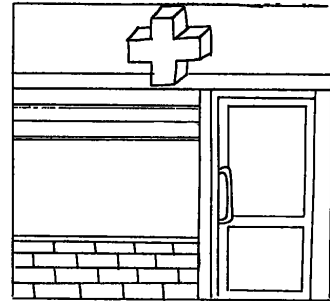

_ _ _ _ macia

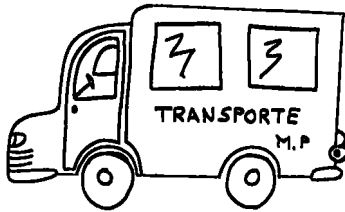

_ _ _ _ goneta



en _ _ _ _ mera

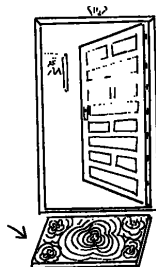

_ _ _ _ pudo

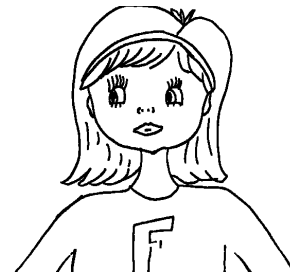

_ _ _ _ ncisca

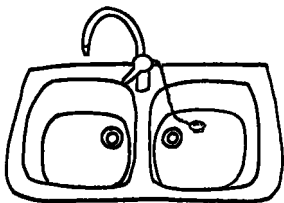

_ _ _ _ gador

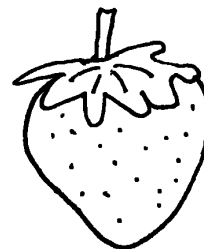

_ _ _ _ sa



Ordema las silabas para formar palabras:

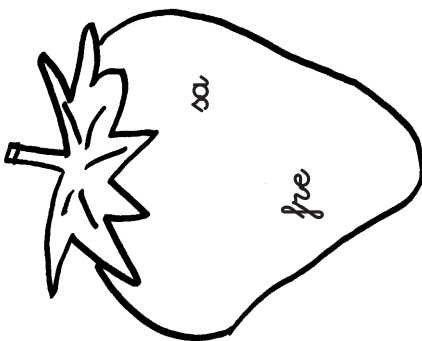

Blank writing lines for the strawberry activity.

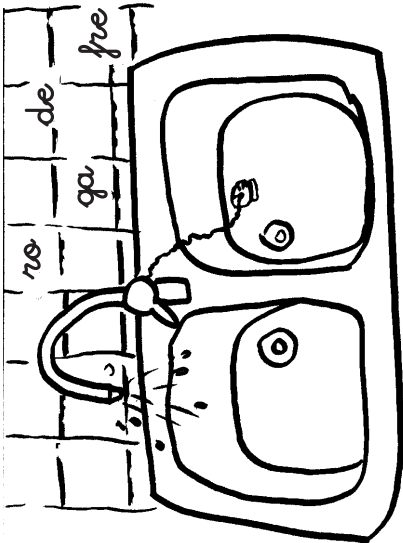

Blank writing lines for the refrigerator activity.

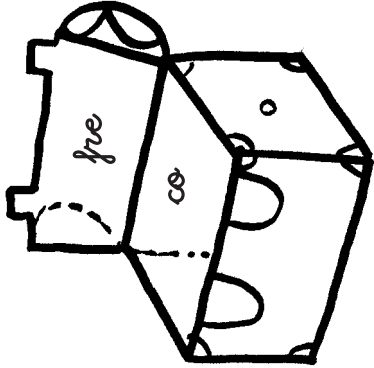

Blank writing lines for the briefcase activity.

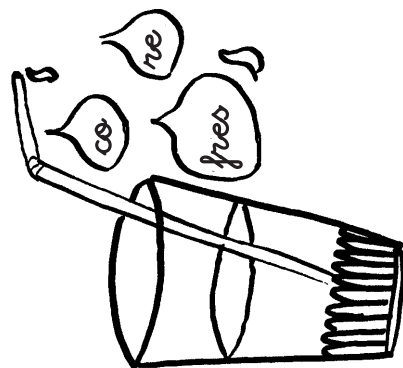

Blank writing lines for the glass activity.

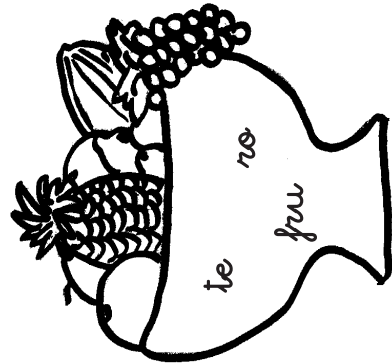

Blank writing lines for the vase activity.

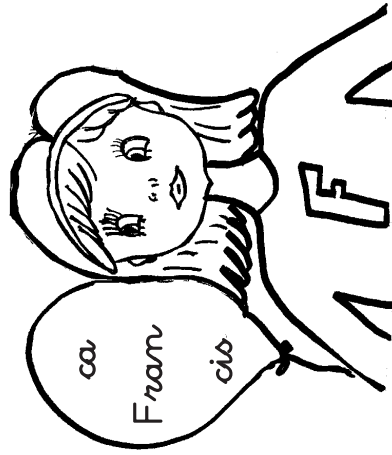

Blank writing lines for the girl and balloon activity.



Escribe el nombre de los dibujos: «fr»:

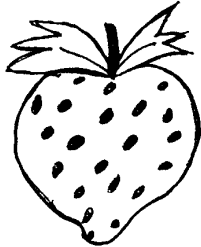

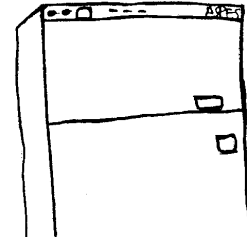





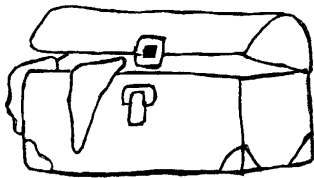

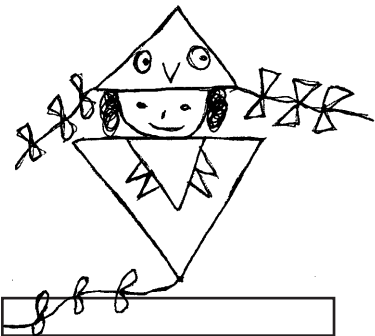

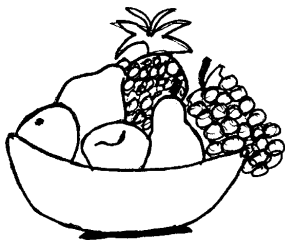

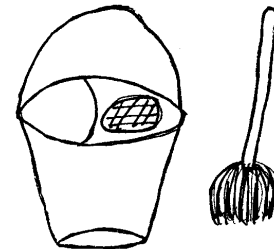



Escribe una frase con el nombre de cada dibujo:

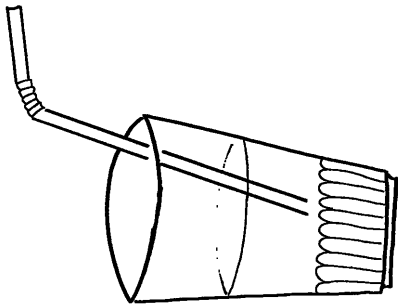

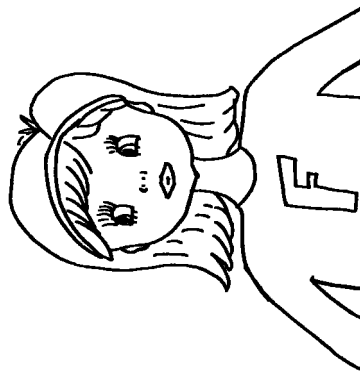

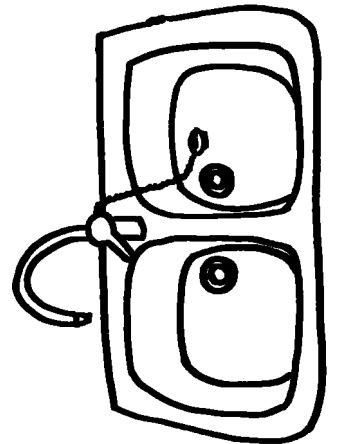



Completa estas frases con las siguientes palabras:

frie - fruta - disfraz - frena - frigorífico

Tengo un para el Carnaval.

El coche de mi padre no

La está en el

Hoy hace mucho



Completa estas frases:



Las  están en el

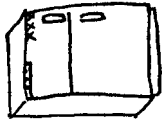

He traído un

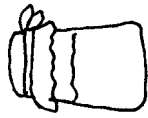

de compota de

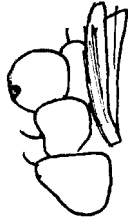

El

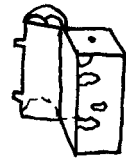

de

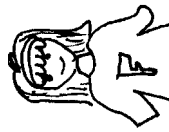

es rojo.

El

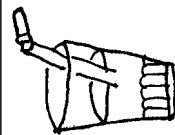

de manzana está frío.



Lee y dibuja estas frases:

Francisca está tomando un refresco con patatas fritas.

El fregador está lleno de fresas.

Este frasco es medicina para el resfriado.

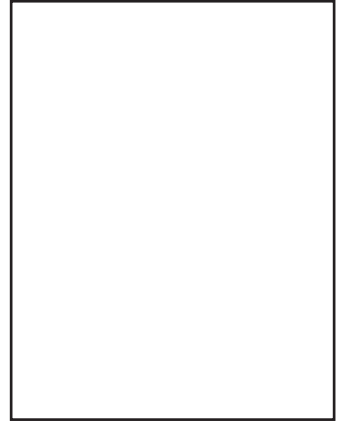
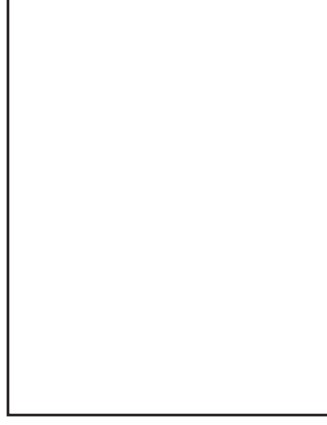
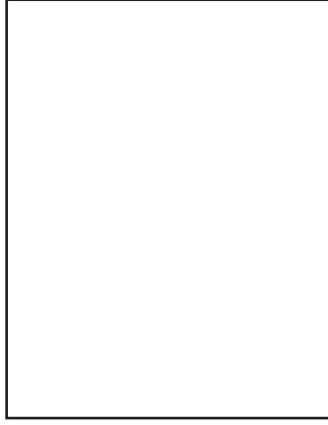



Completa con fr... o f...r las siguientes palabras:

Lassas delgerifico ya estánas.

.....nando está bebiendo un re.....sco.

Lagemeta va cargada deta.

El coche deltero nona.

La en.....mera tiene unsno de jarabe.



Ordema estas palabras y forma las frases:
una Francisca madura. me da fresa

rote. de está frigorífico mi El tía

los cofre de juguetes ha El perdido. se

da fruta Mi fresa. me madre



Escribe palabras que empiecen por:

fr

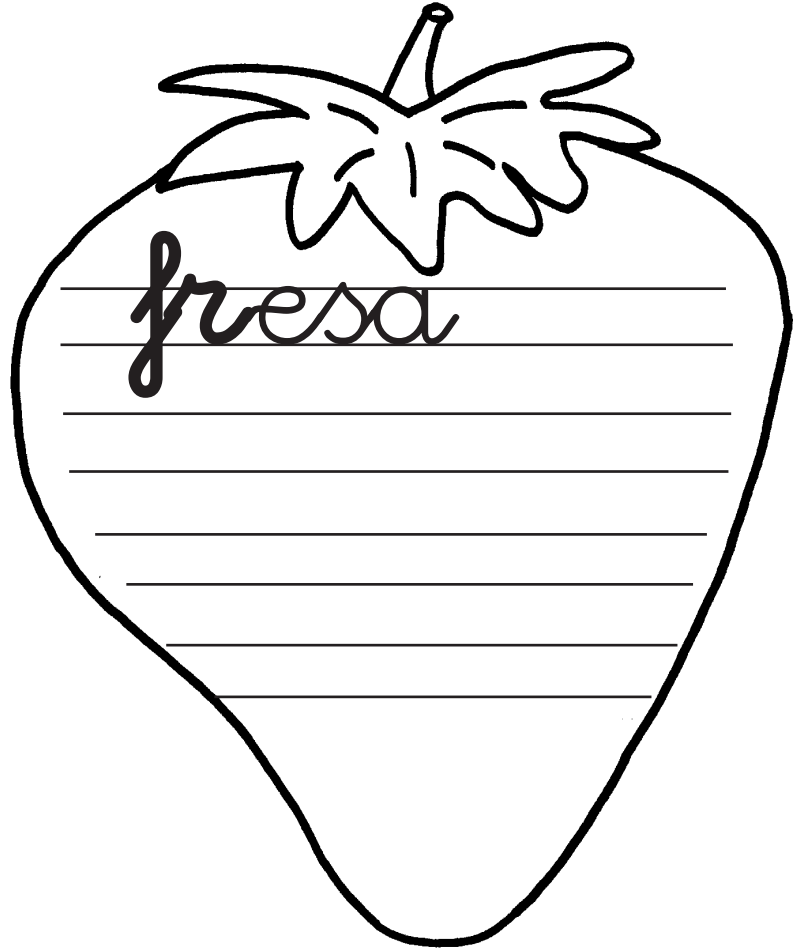

f.....r

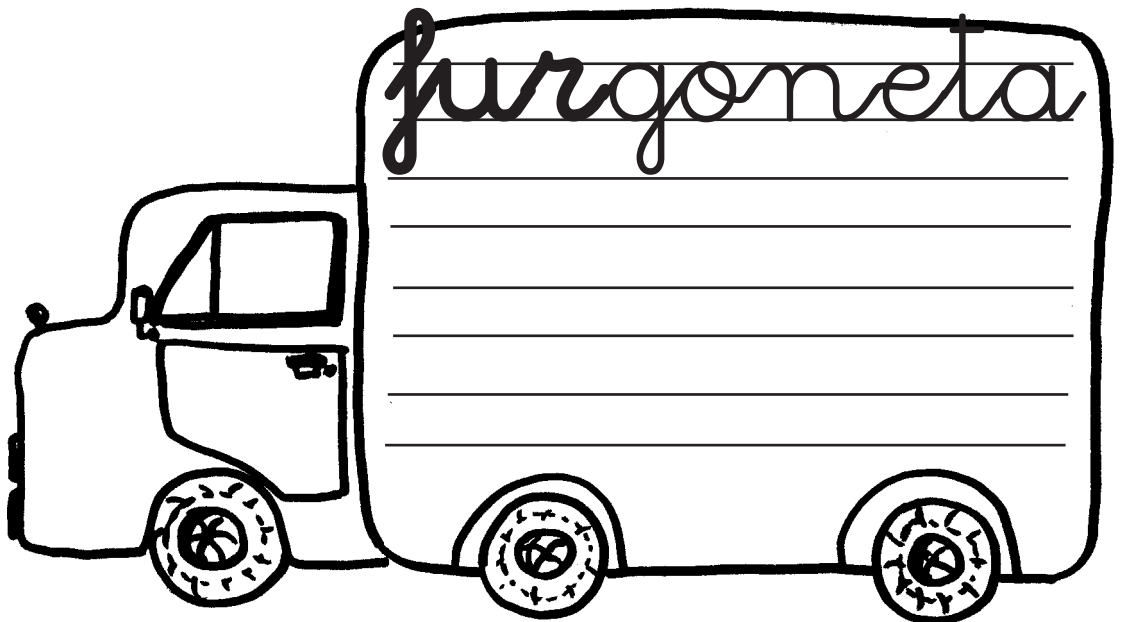



SOPA DE LETRAS

Busca en esta sopa de letras las siguientes palabras:

FRESON FRESAS FRESCO

FRISO OFRENDA COFRE





CRUCIGRAMA

Resuelve:

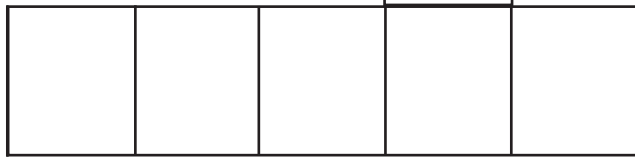
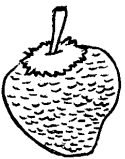
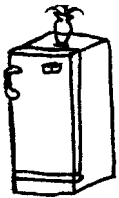
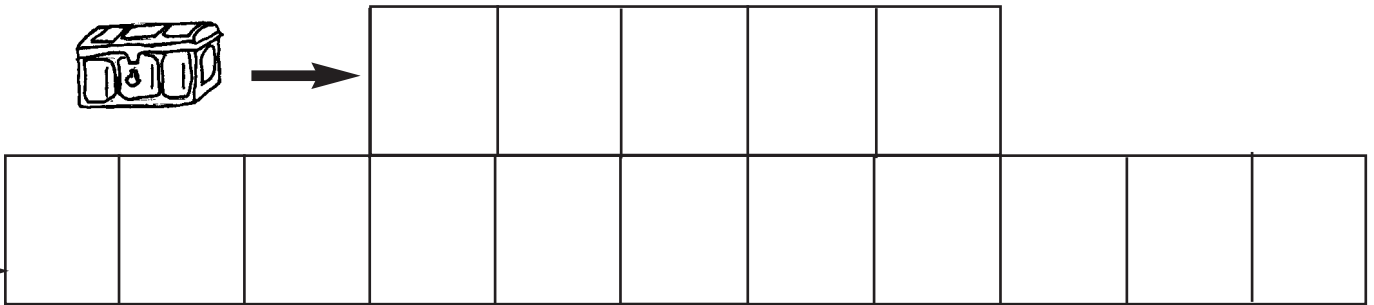



Adivina, adivinanza:

En medio de un prado blanco,
hay una flor amarilla
que se la puede comer
el mismo rey de Sevilla.

Es el