

Fig. a

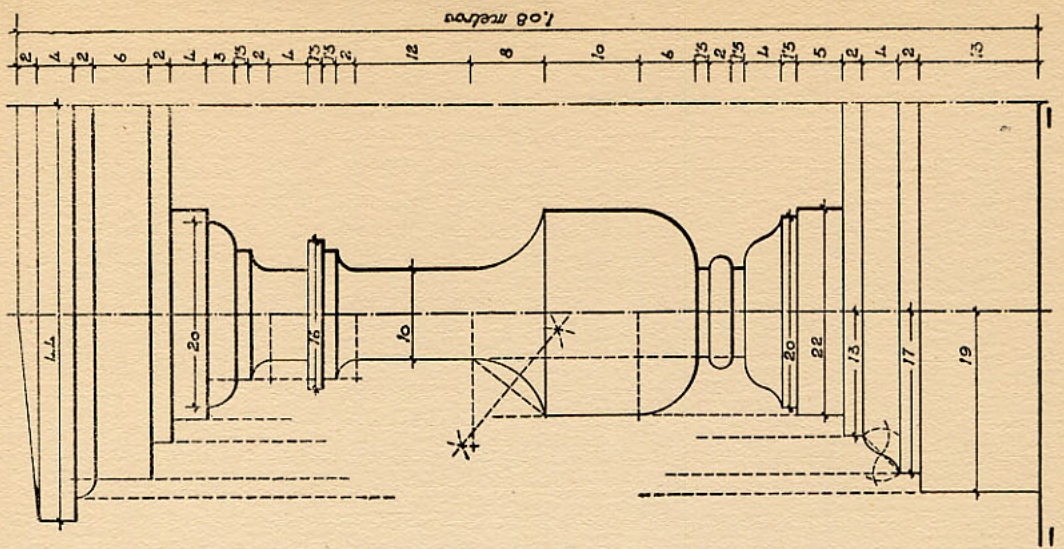

Fig. b

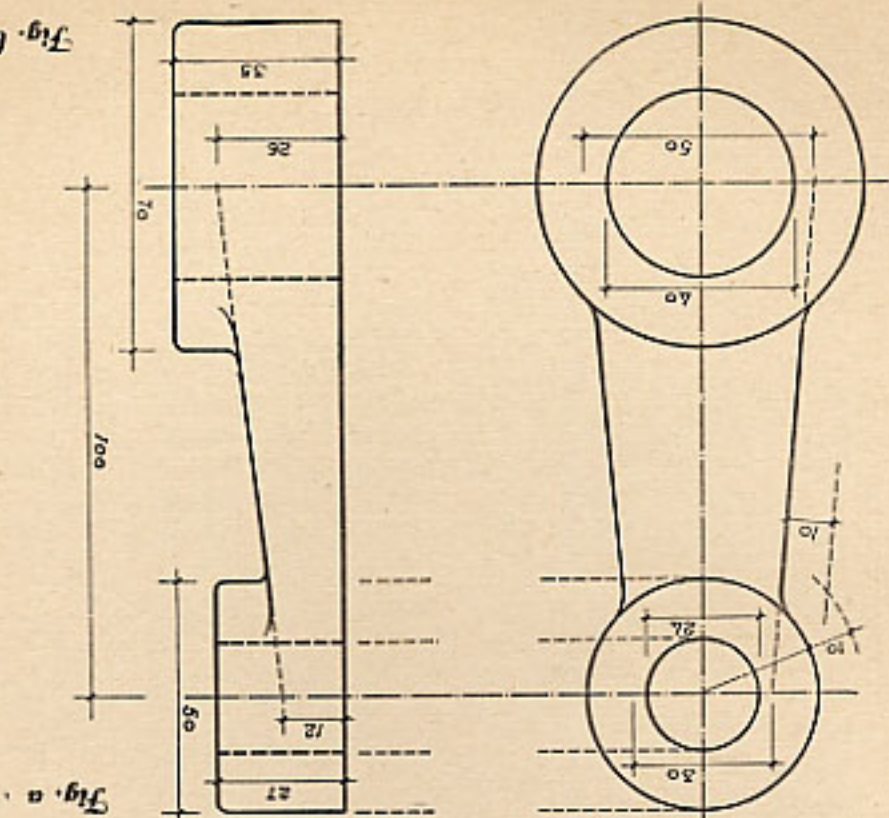
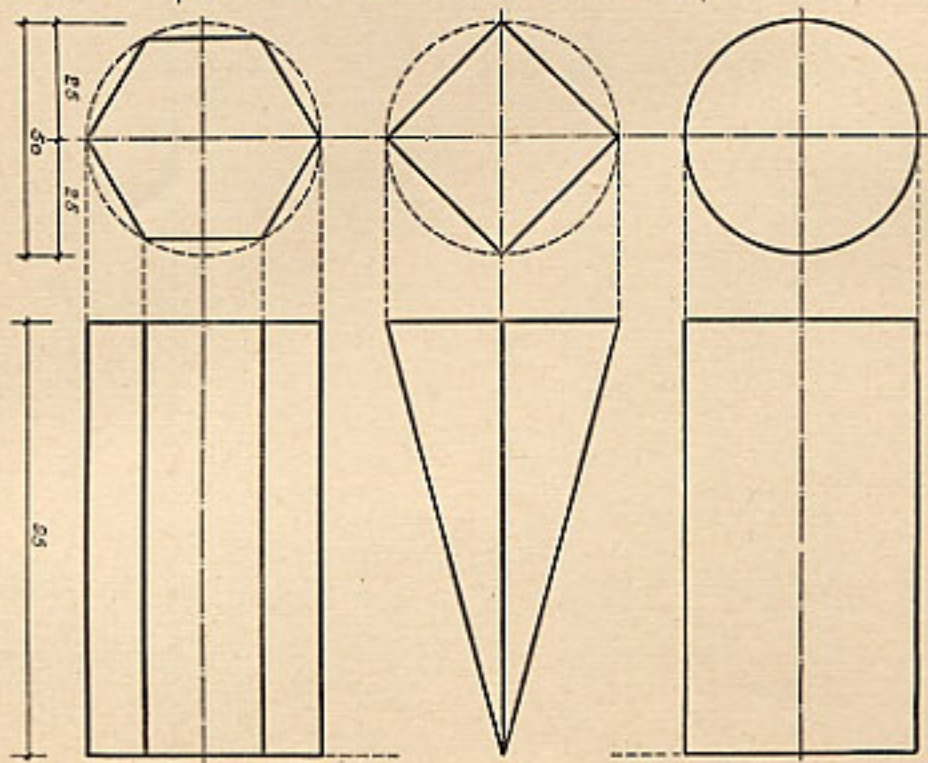
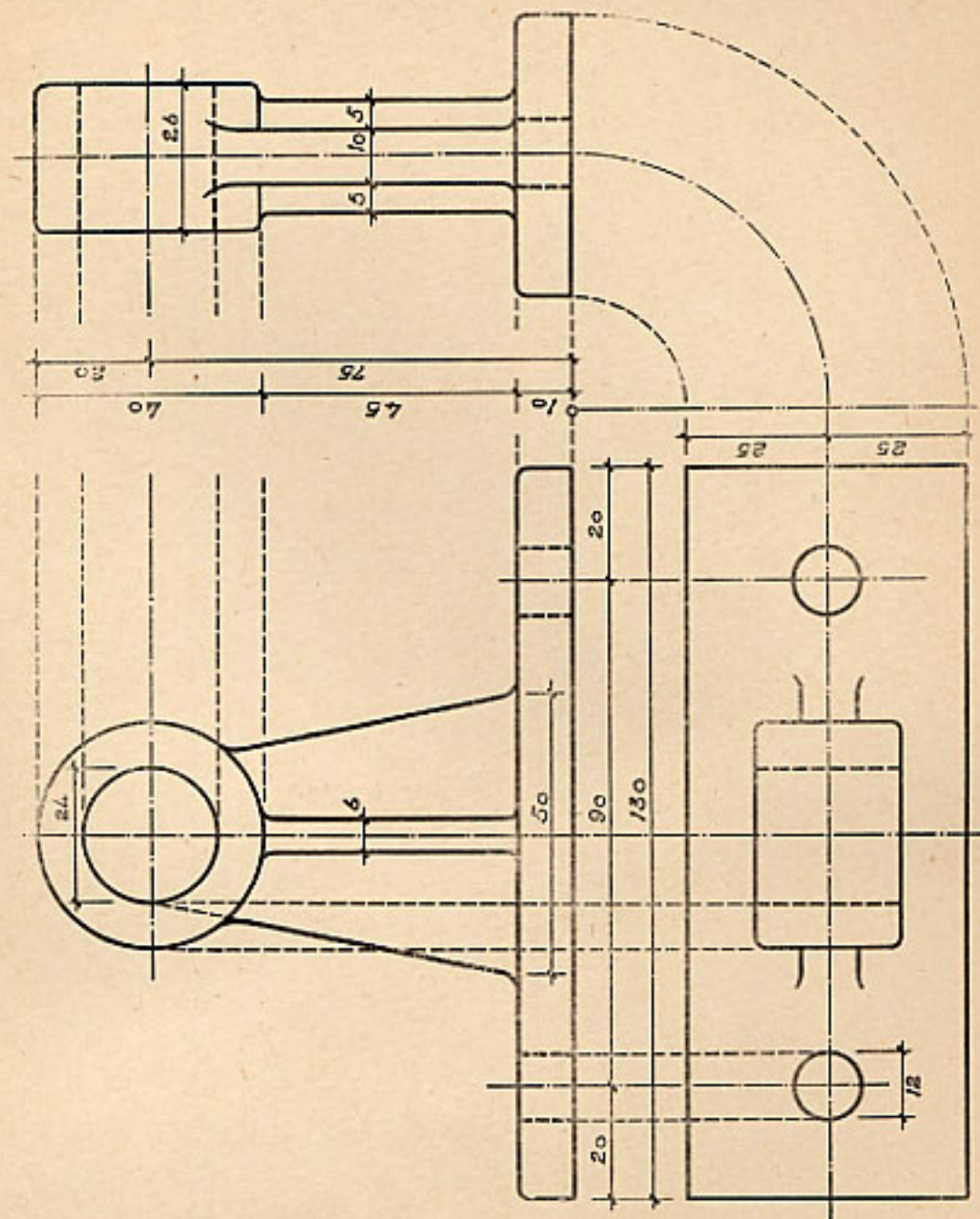
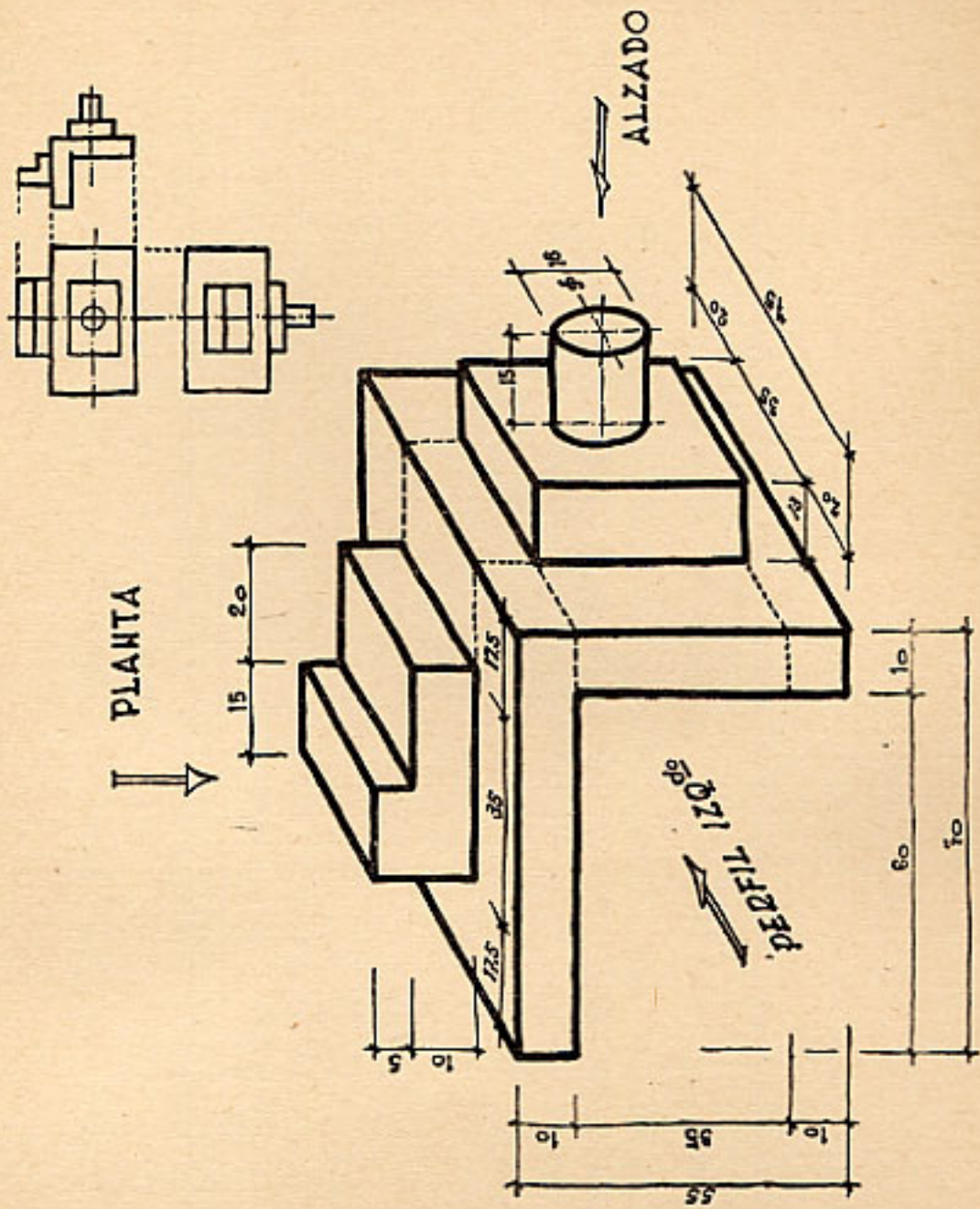

Fig. 6

Fig. a

Experto Vigas





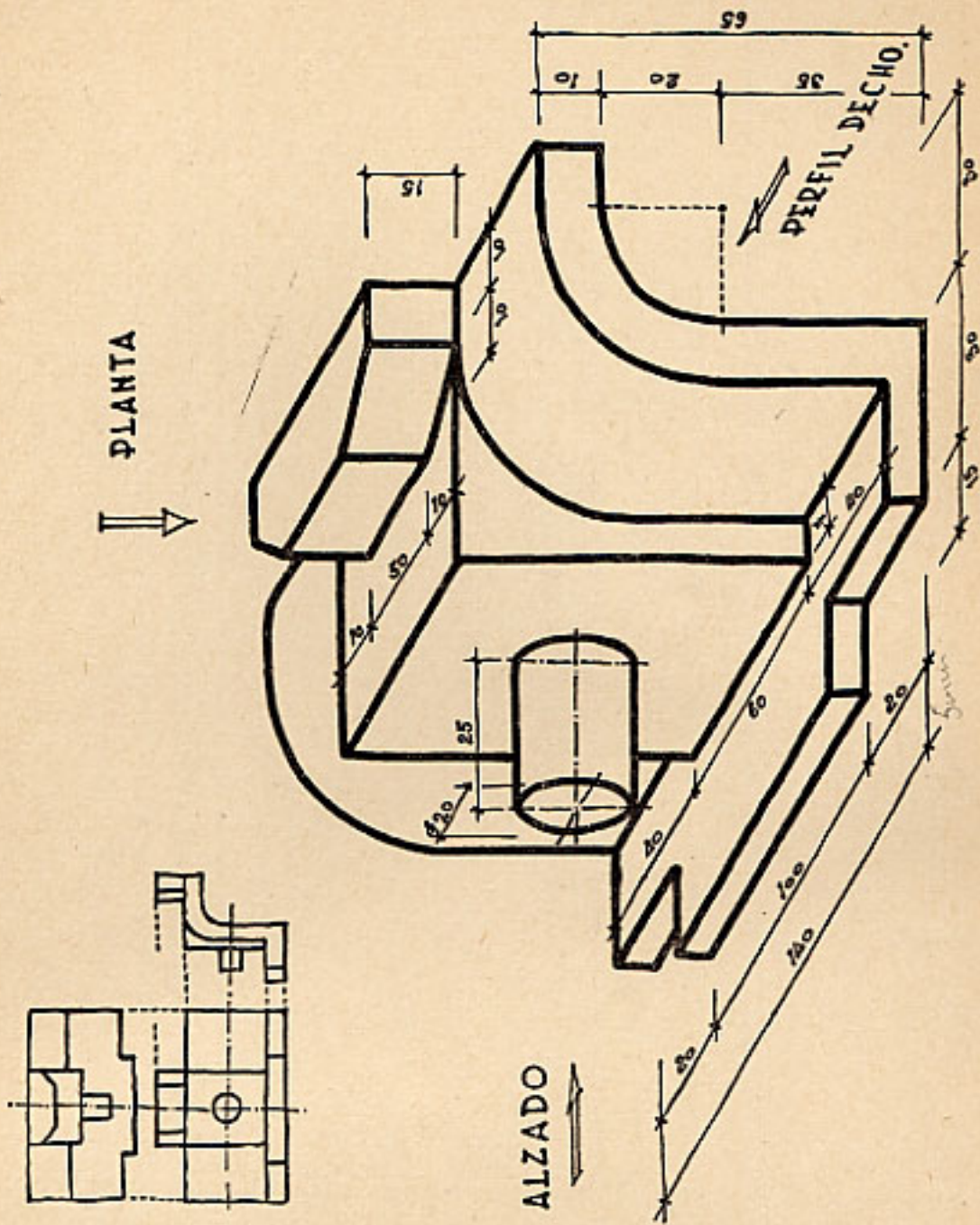

H $\frac{D}{3}$ $\frac{D}{3}$ $\frac{D}{3}$ H'

horizonte

Línea de

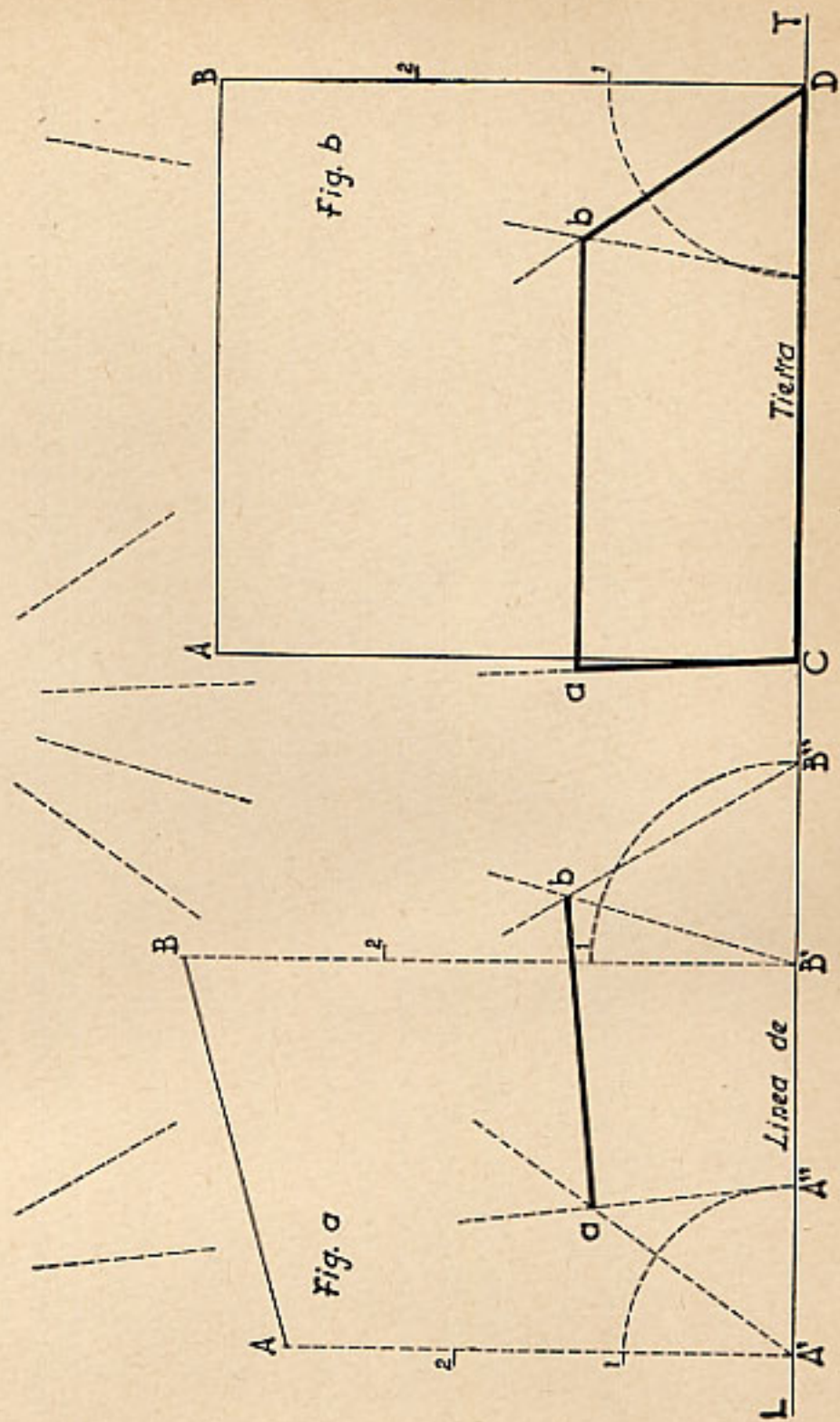

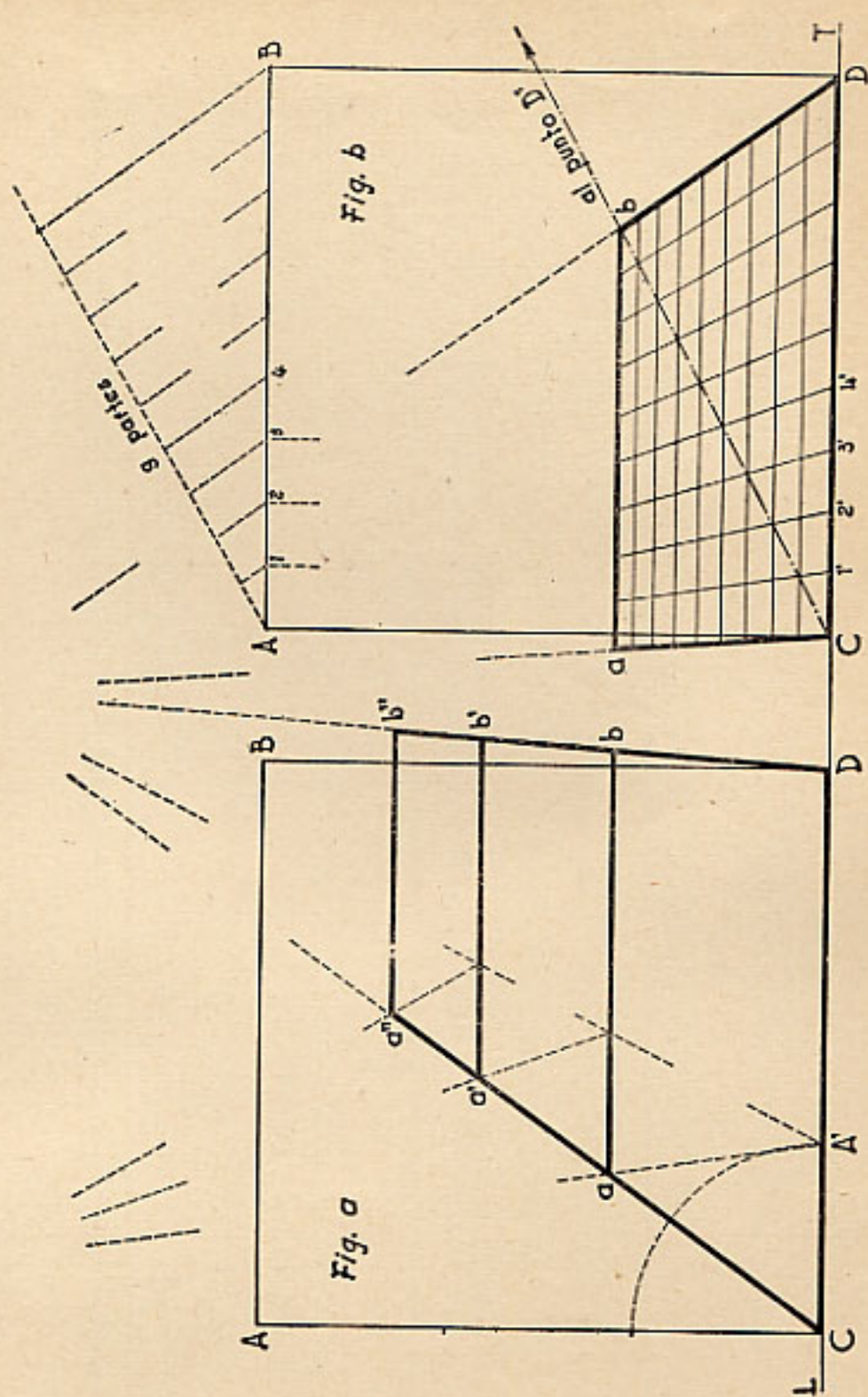
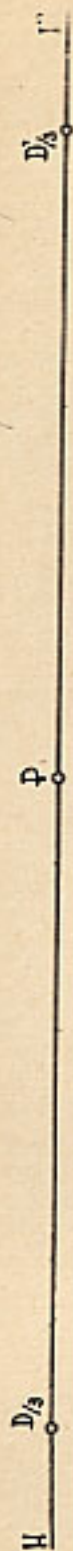

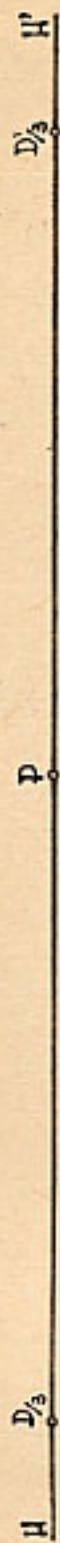

Fig. a

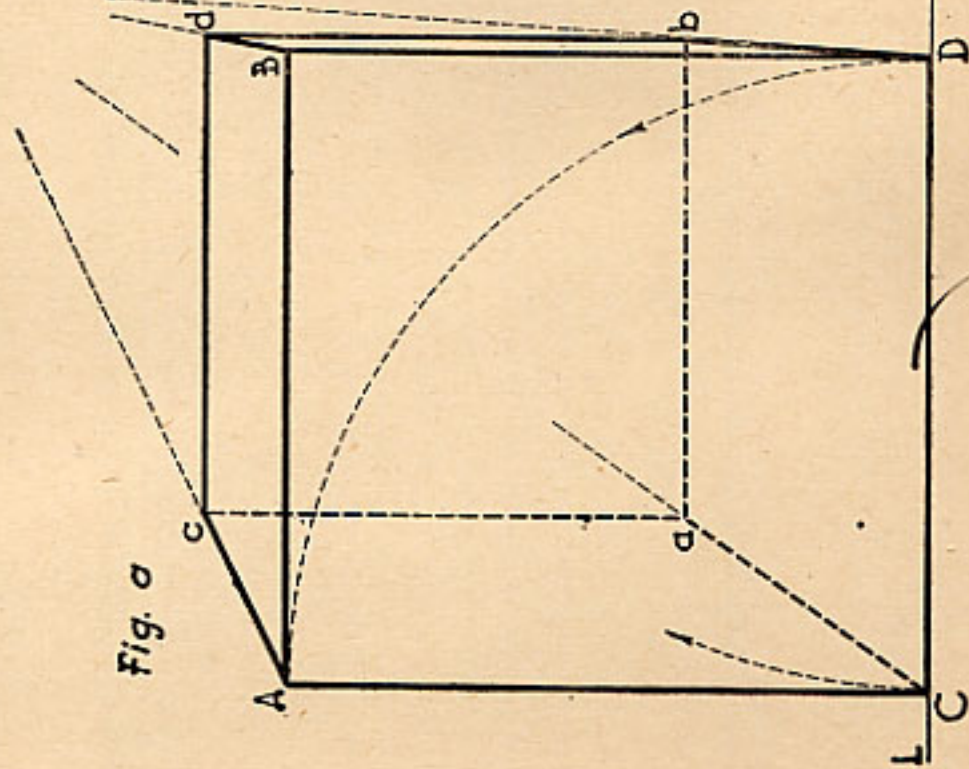
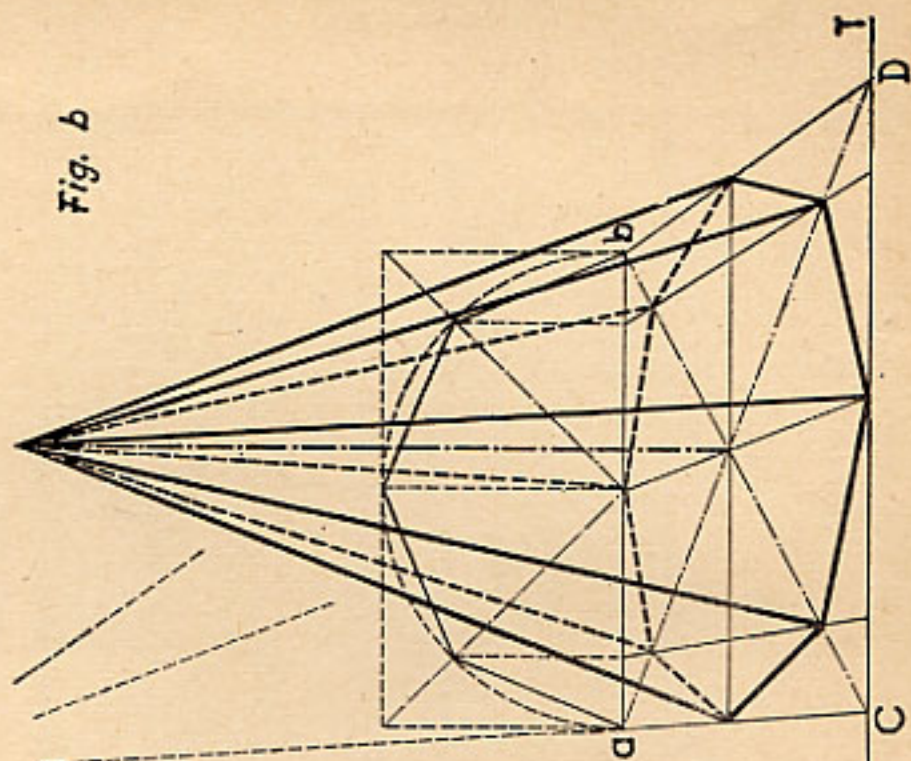
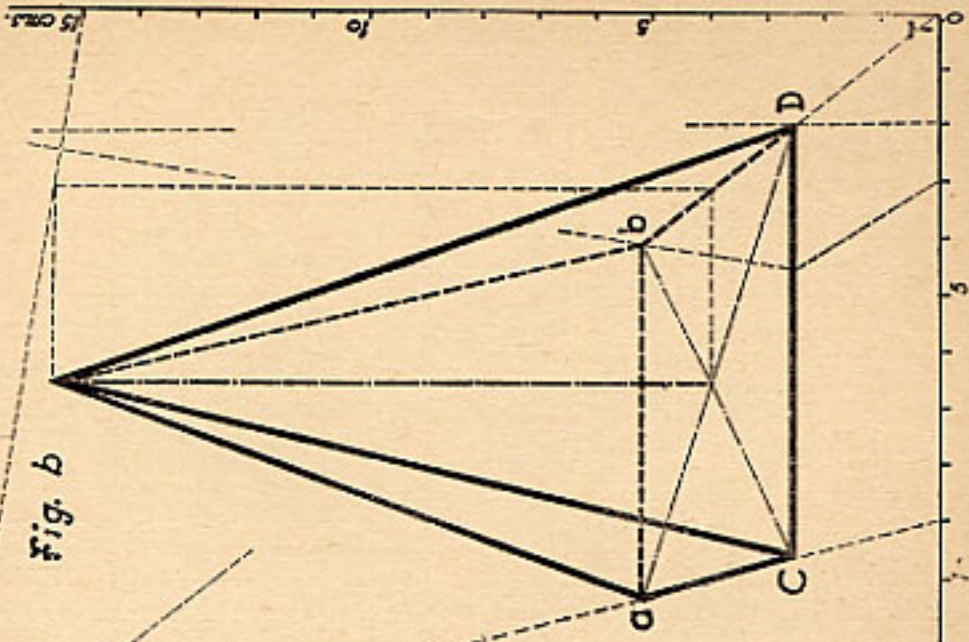
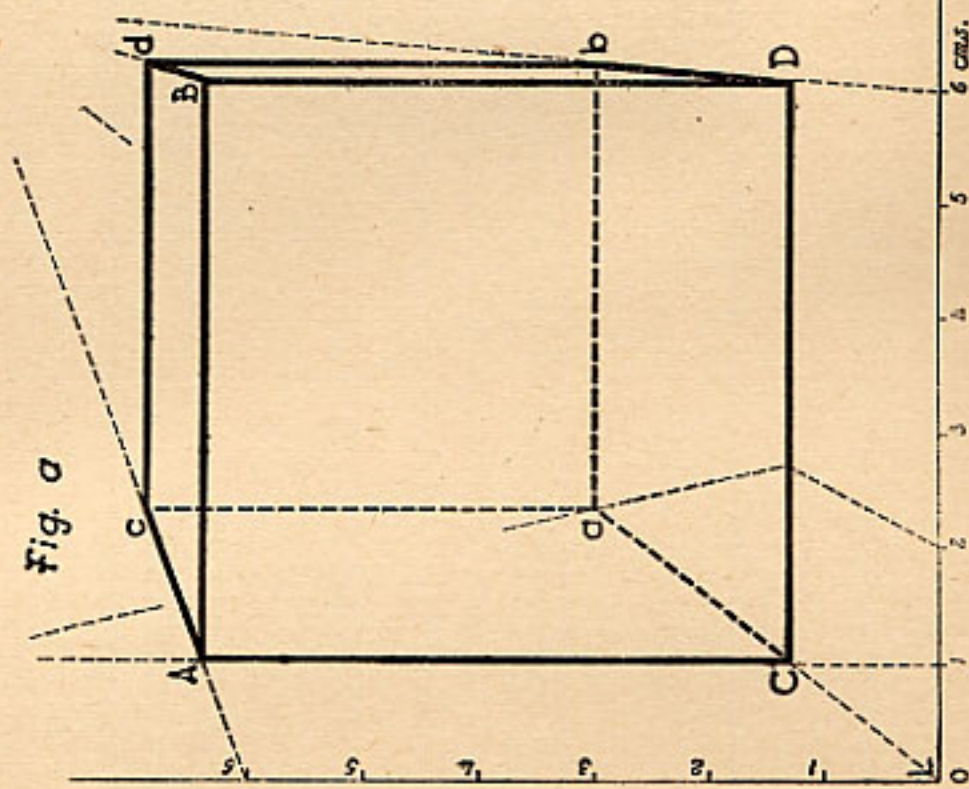

Fig. b



H $\frac{D}{8}$ P $\frac{D}{8}$ H'



0 1 2 3 4 5 6 cent.

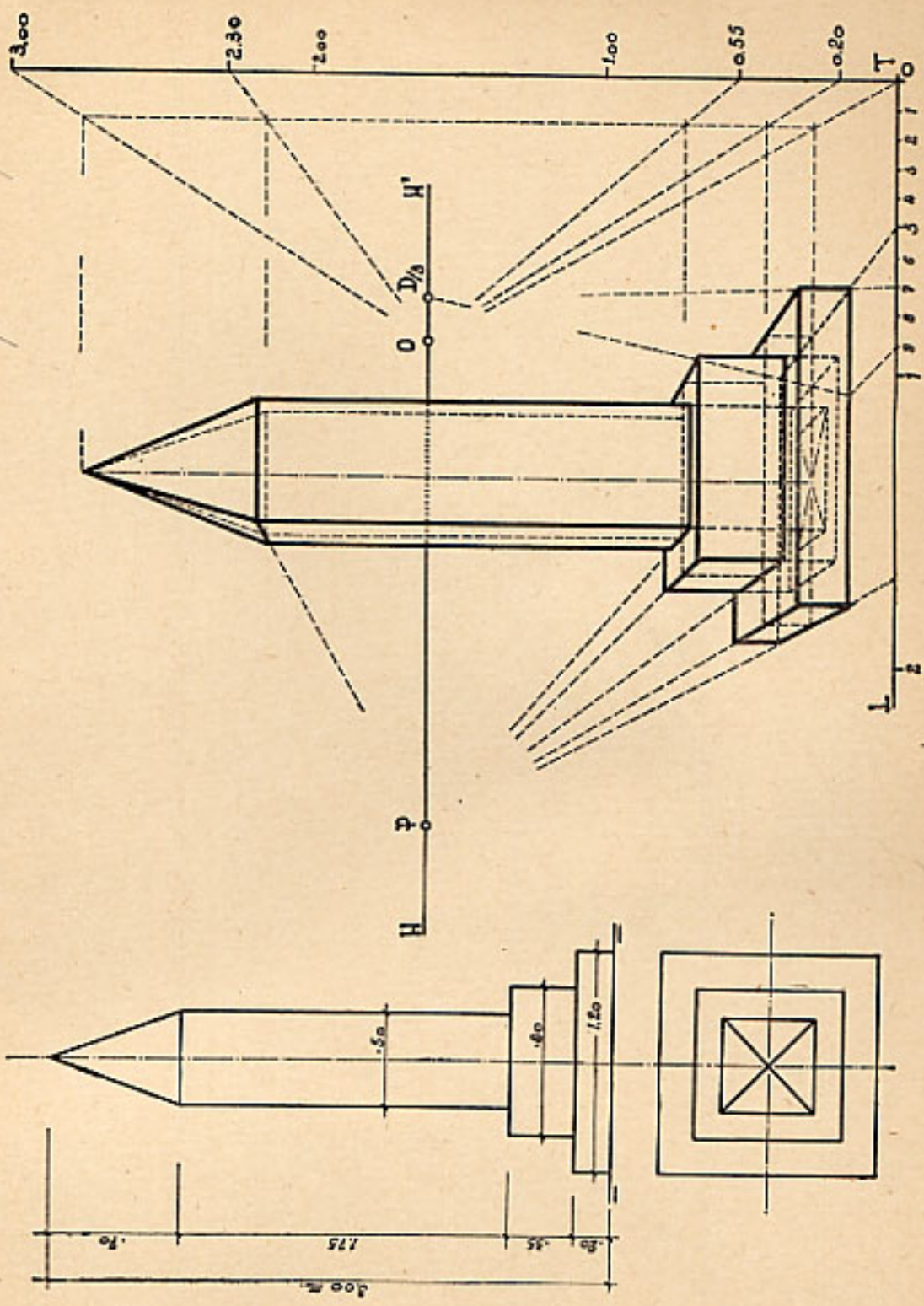

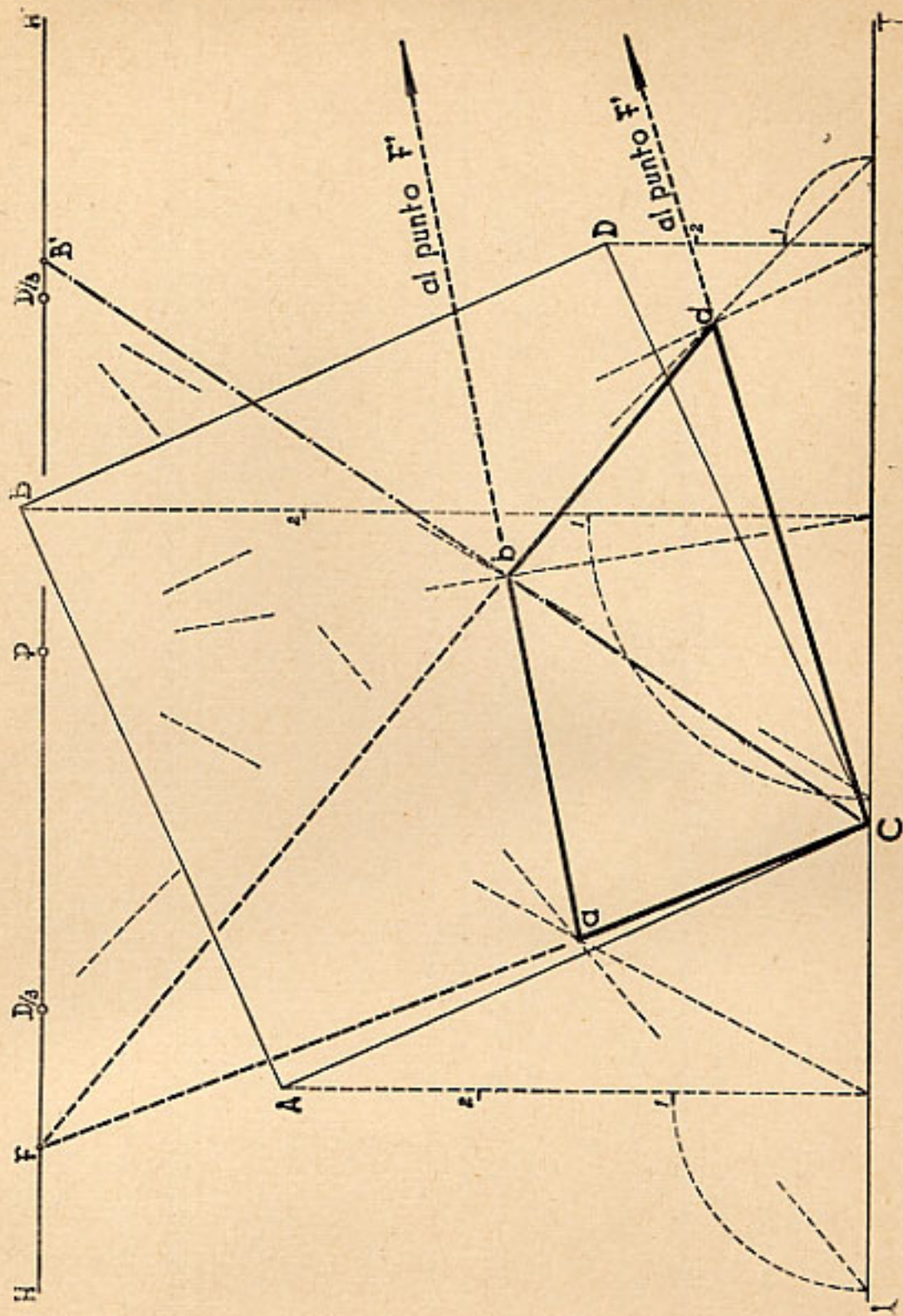

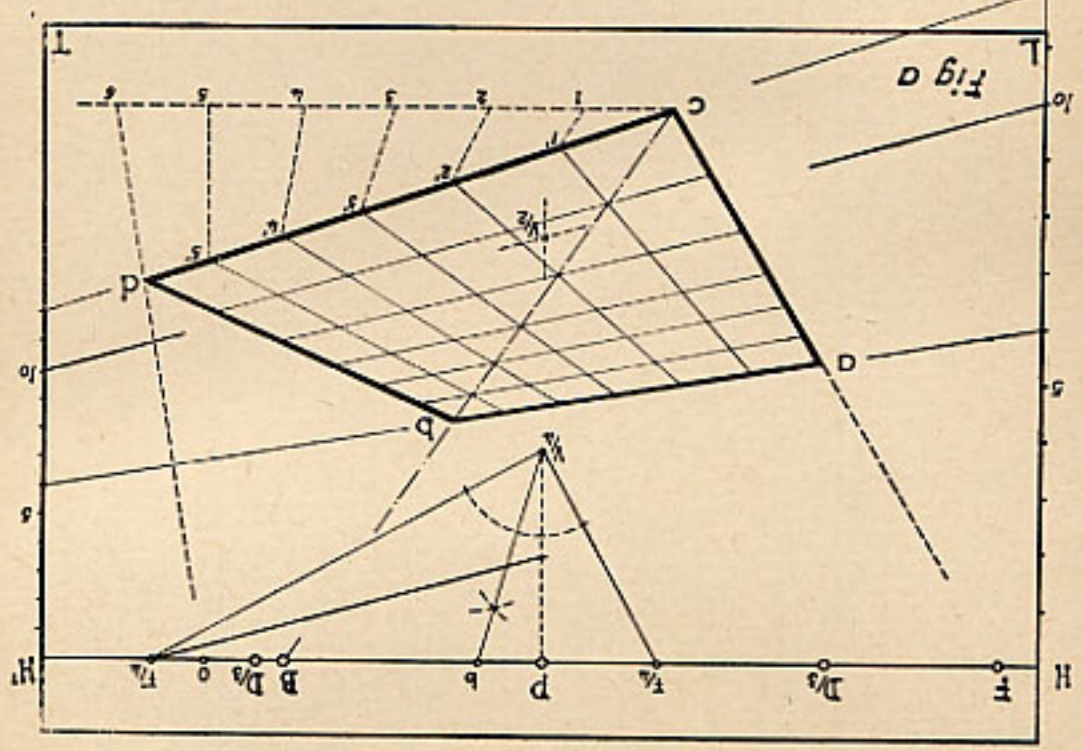
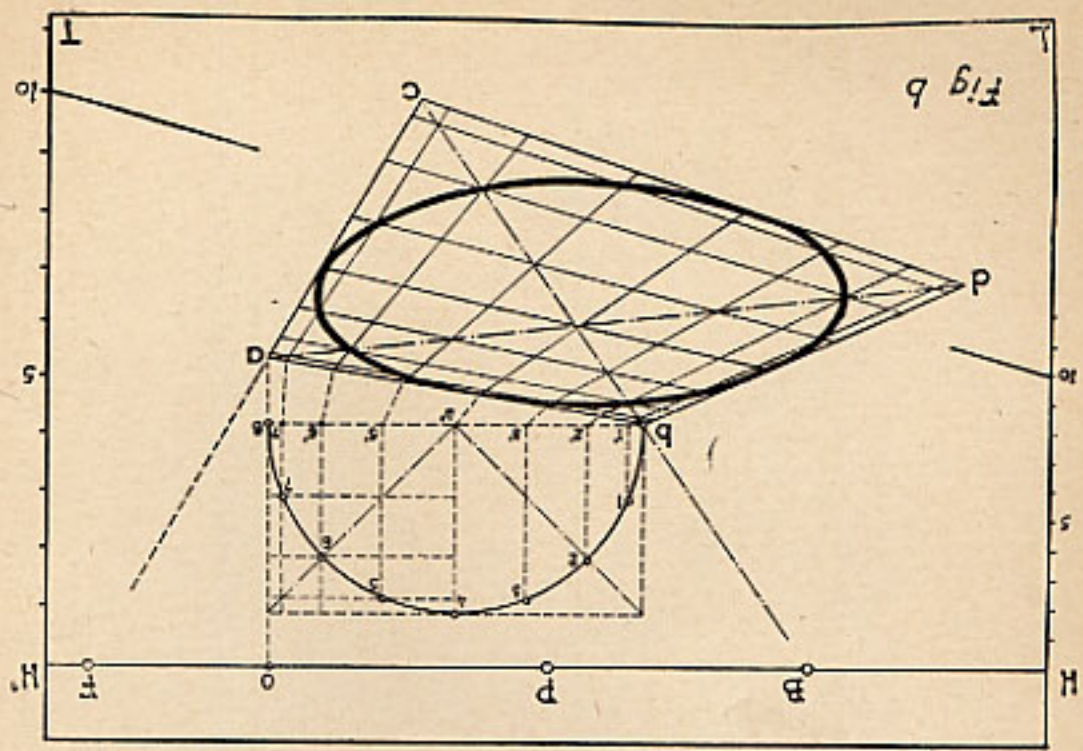

Método de Dibujo. — Quinto año de Bachillerato. — Lámina 15. — Alumno *Eugenio Meigs*

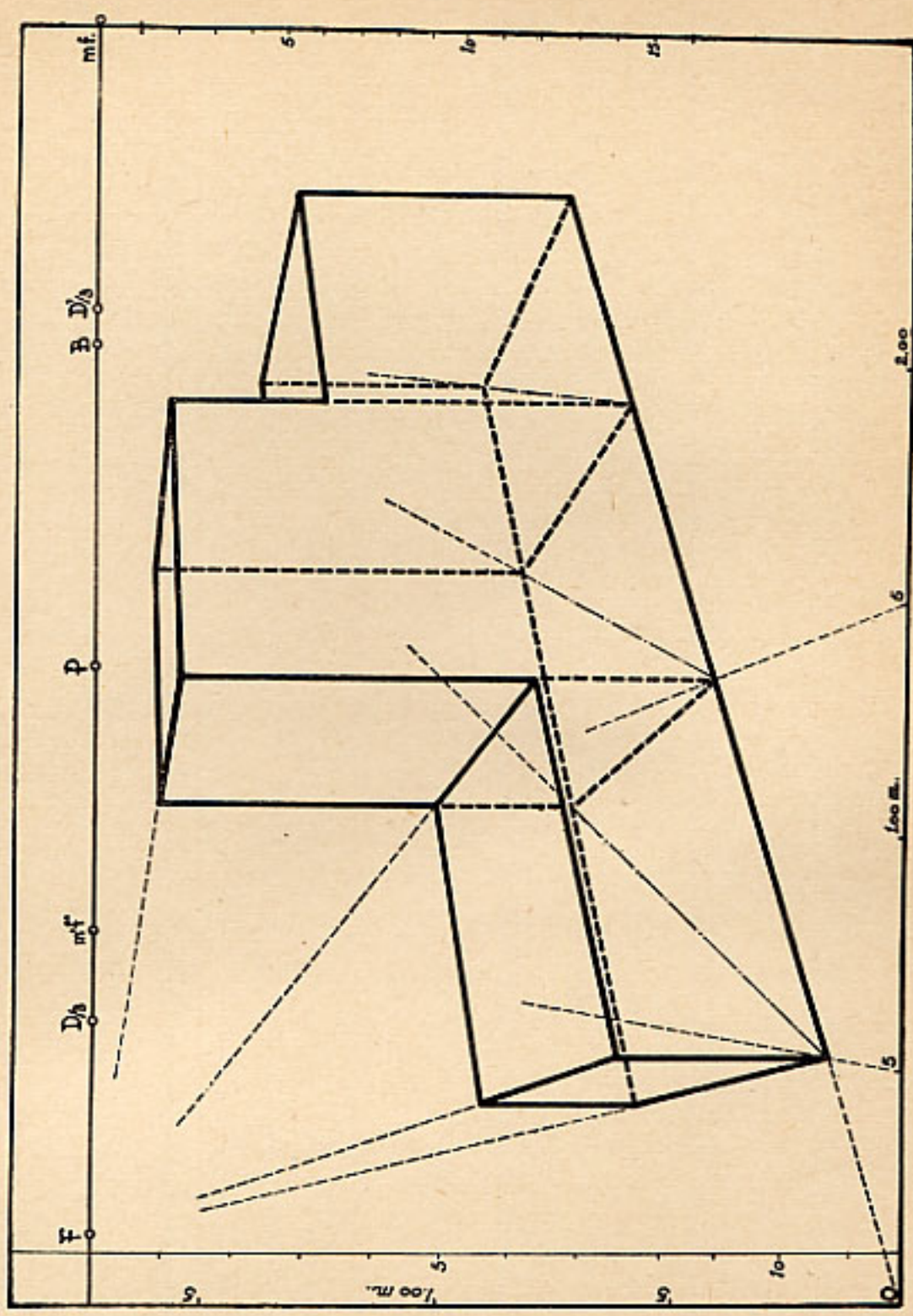

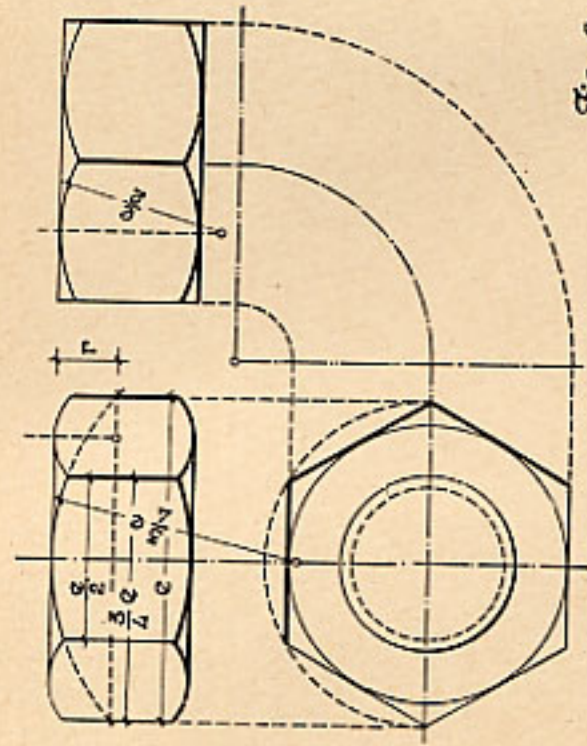

Fig. a

Fig. b

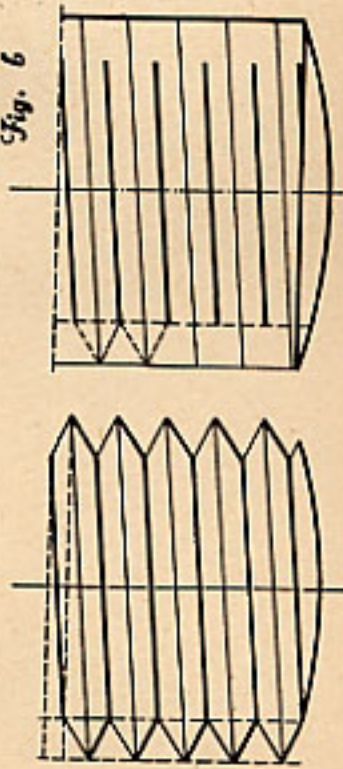
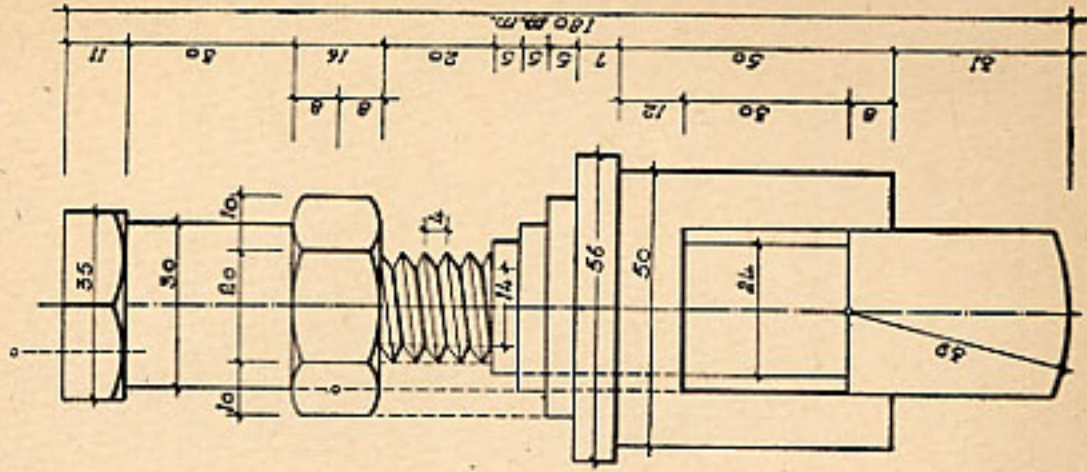
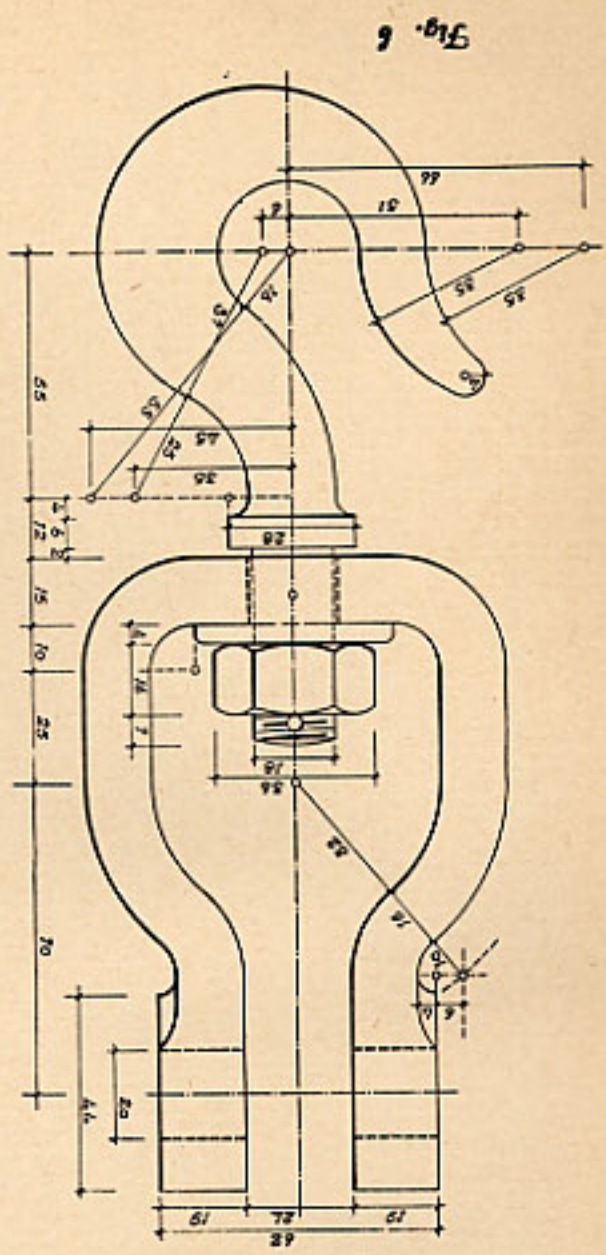
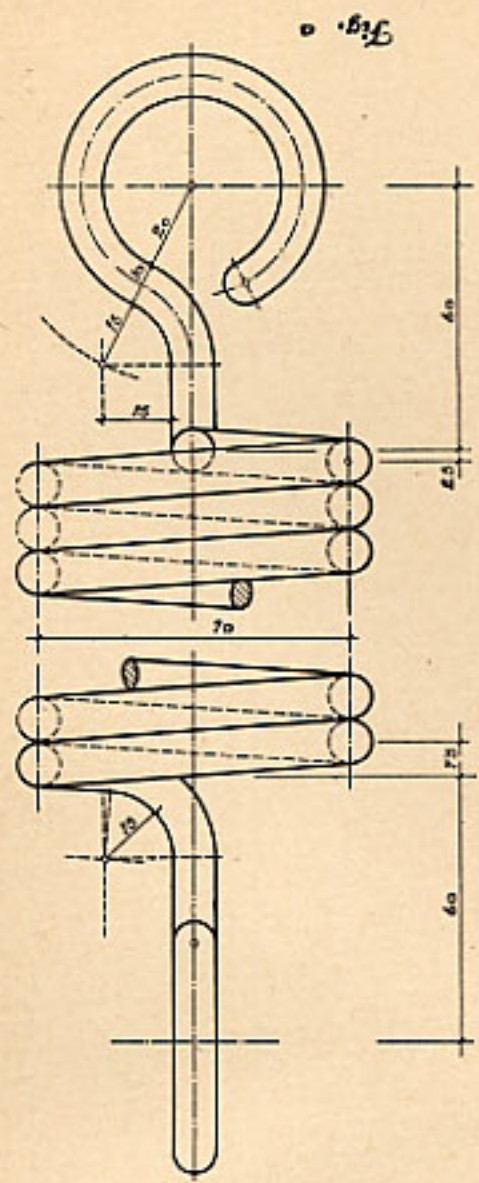
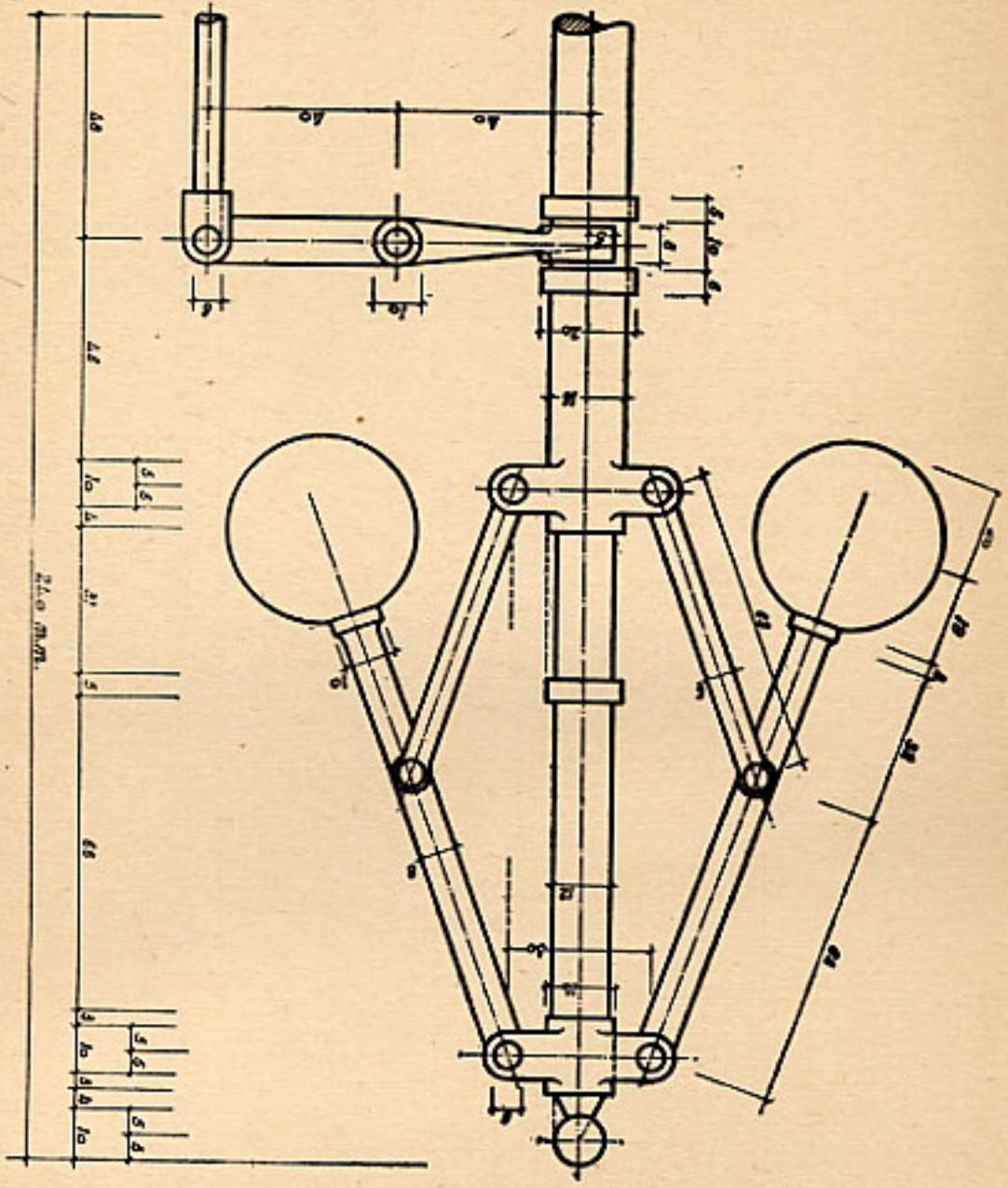

Fig. c





Método de Dibujo. — Quinto año de Bachillerato. — Lámina 18. — Alumno *Equino Mejías*



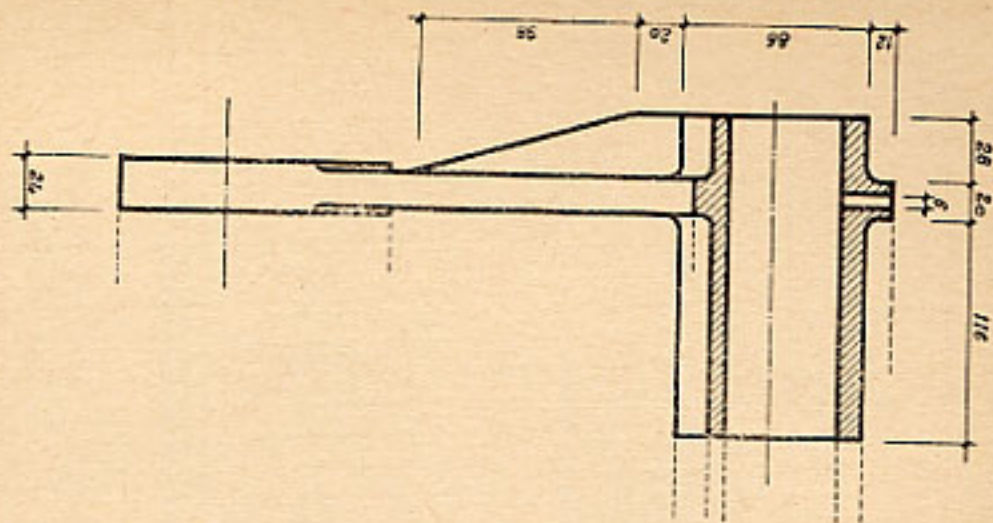
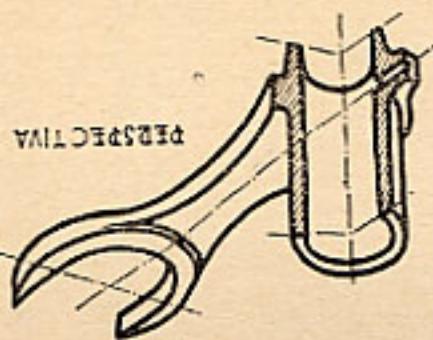
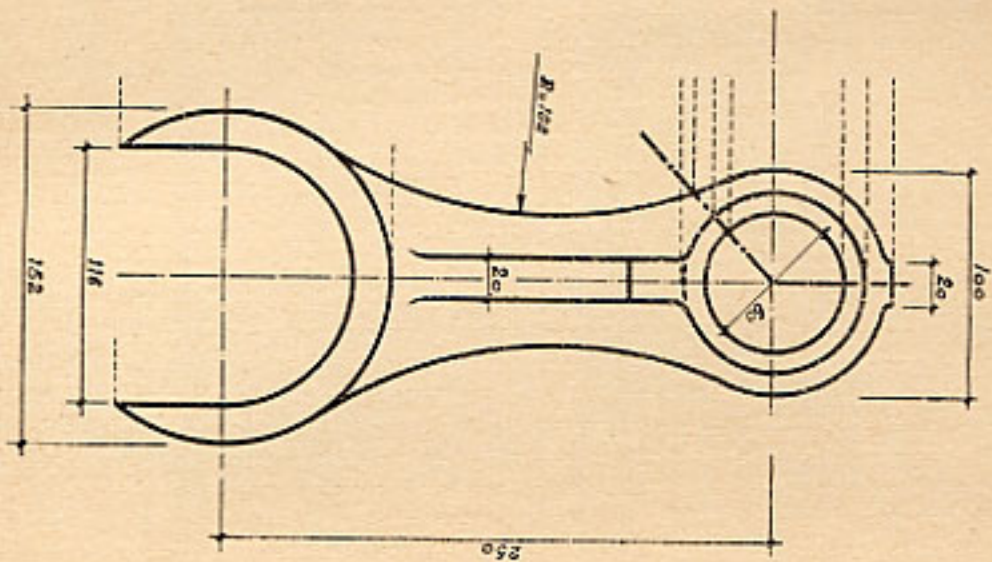

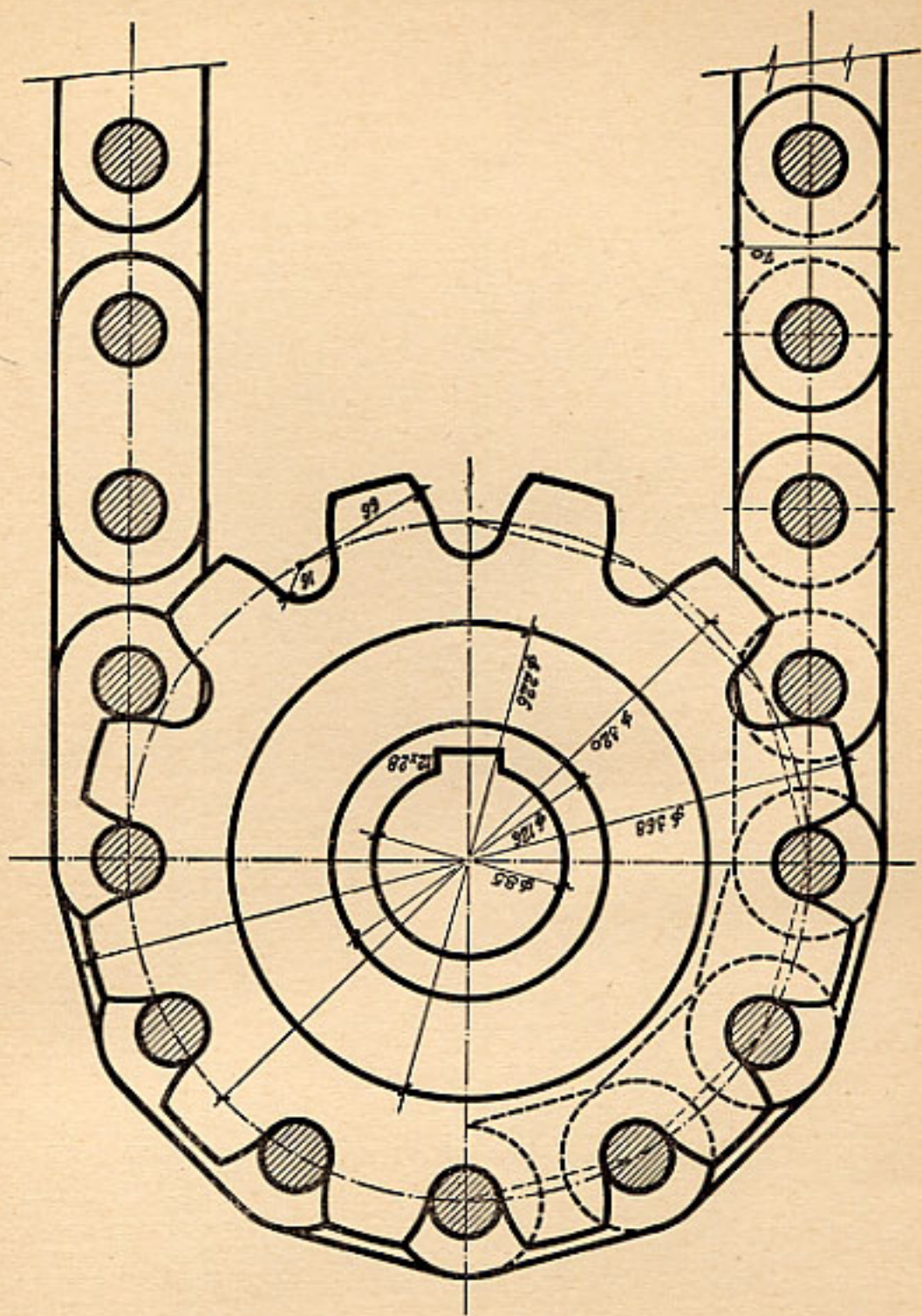

partes 12 9 6 3 0 1 2 3 4 5
 ESCALA de MODULOS
 5 módulos

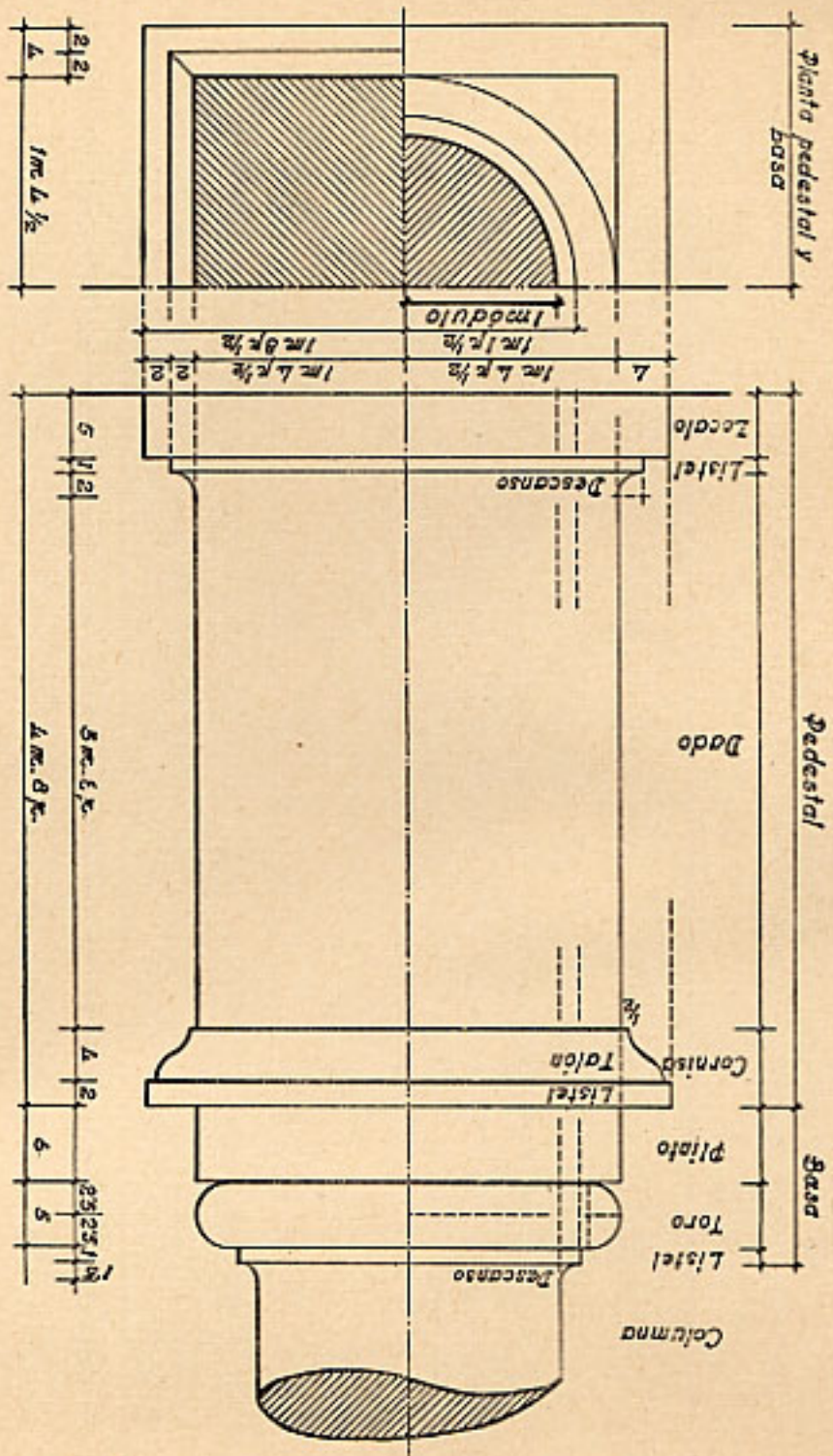

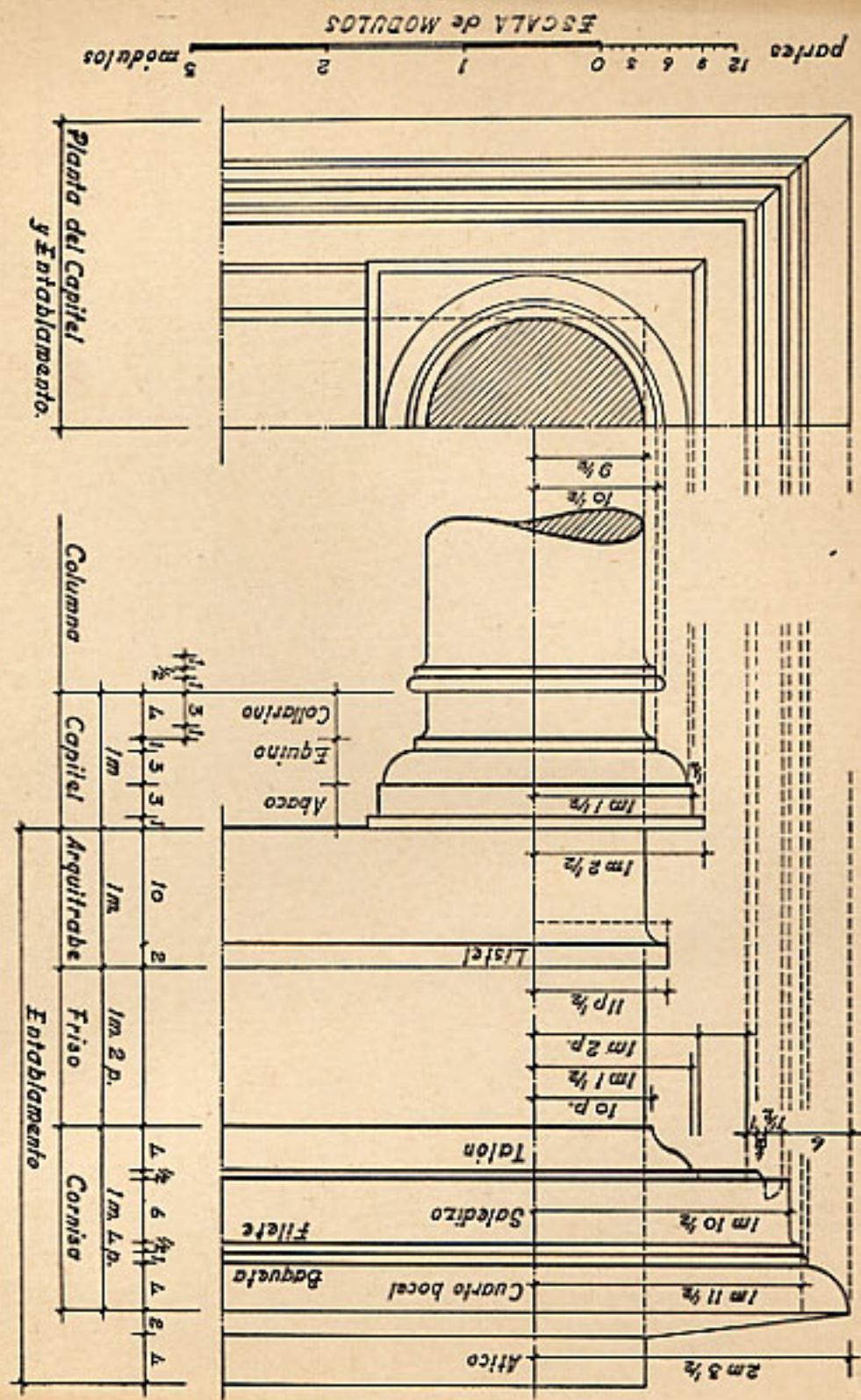

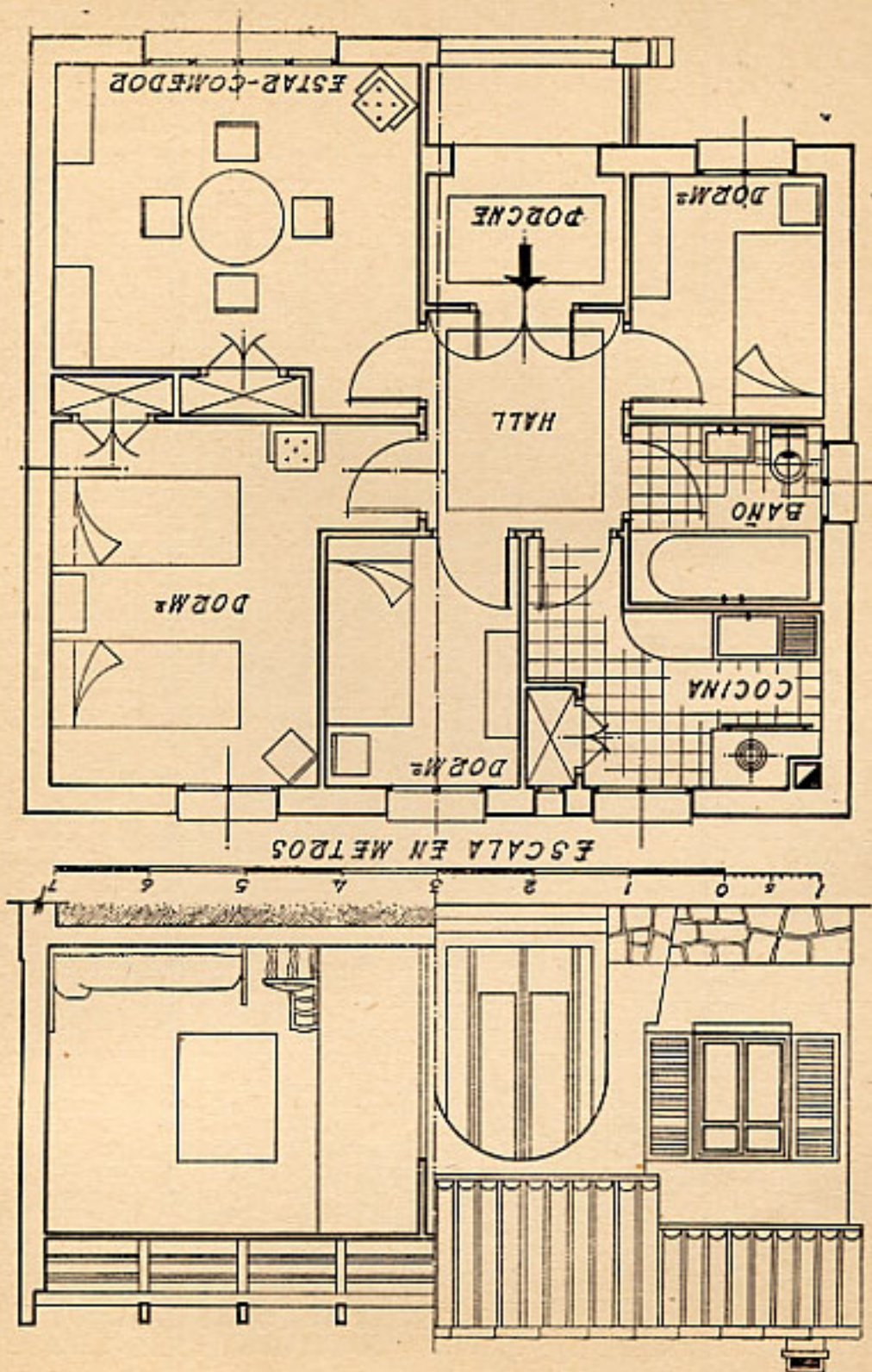

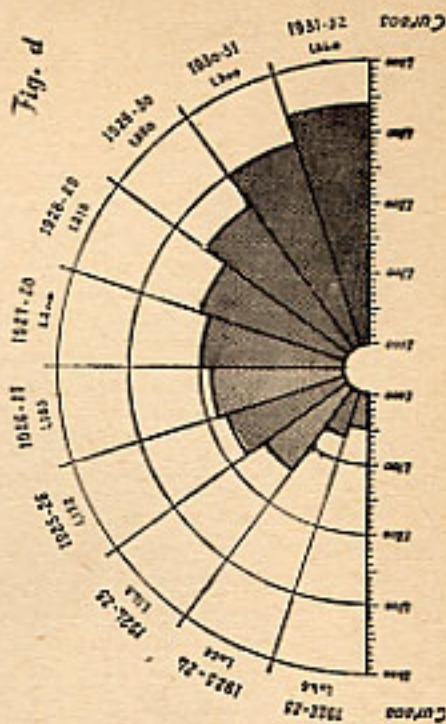
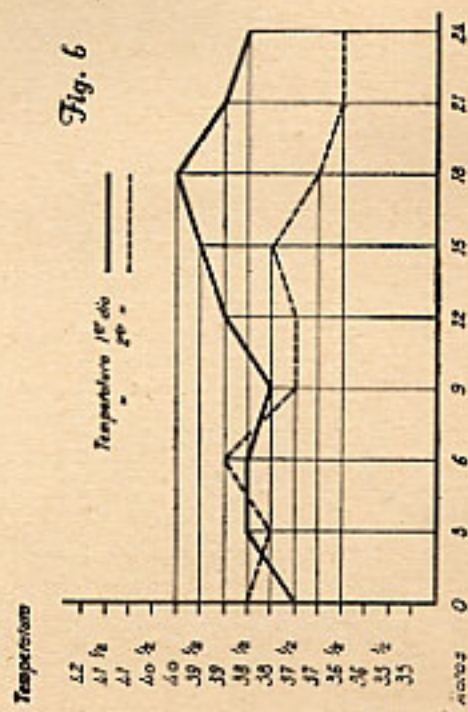
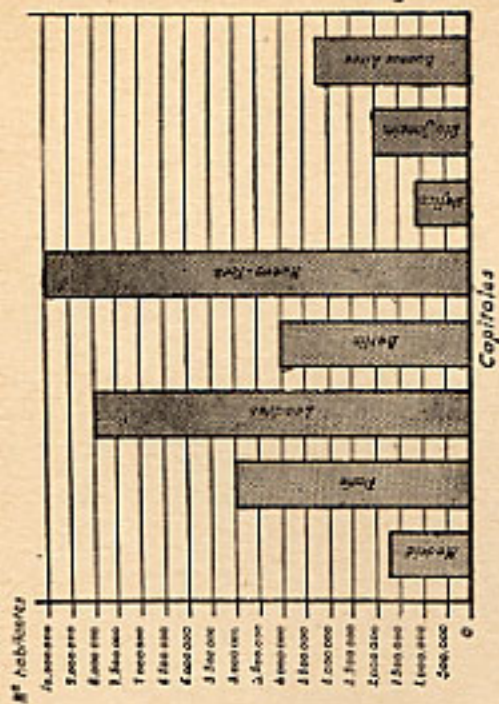
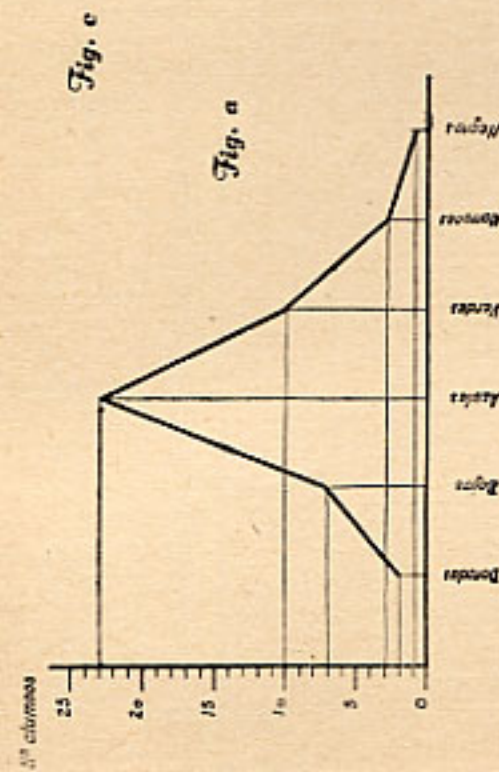



Erial (negro)



Huertas (verde)



Monte alto (verde)



Tierras de labor (negro)



Viñas (negro)



Arenal (negro)



Arroyo (azul)



Camino (negro)

CARRETERAS (rojo)

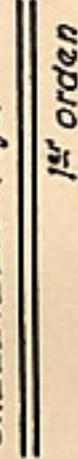

1^{er} orden



2^o orden



3^o orden

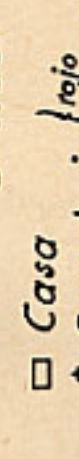

□ Casa

⊕ Cementerio } rojo

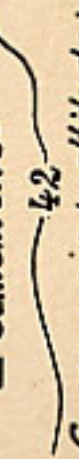

42

Curva de nivel y altitud (verde)

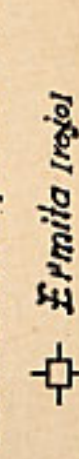

⊕ Ermita (rojo)

Ferrocarril doble vía (negro)

⊕ Iglesia (rojo)



LIMITES

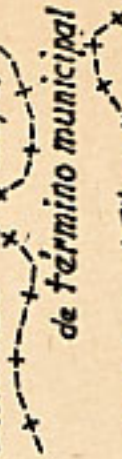

de término municipal

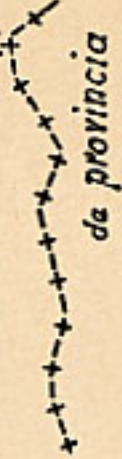

de provincia

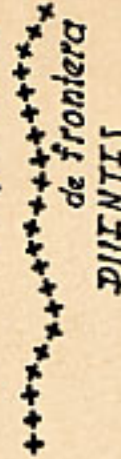

de frontera

PUNTES

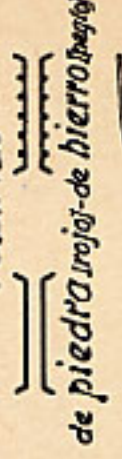

de piedra roja de hierro (negro)



Rio

(azul)

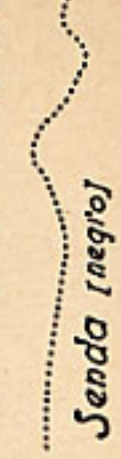

Senda (negro)

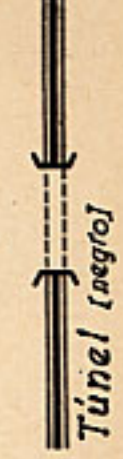

Túnel (negro)

