

10

unidad didáctica



LOS MEDIOS DE TRANSPORTE



Bloque 4

Orientaciones metodológicas

Sobre grafomotricidad. Maduración perceptivo motriz:

1. Búsqueda de lo diferente.
2. Completar las imágenes.
3. Discriminación figura-fondo.
4. ordenación de viñetas.
5. Laberinto.
6. Puzzle.
7. Búsqueda de acciones correctas e incorrectas.
8. Identificación de imágenes atendiendo a conceptos
9. Actividades de coloreado, recortado y picado.



Busca las diferencias:

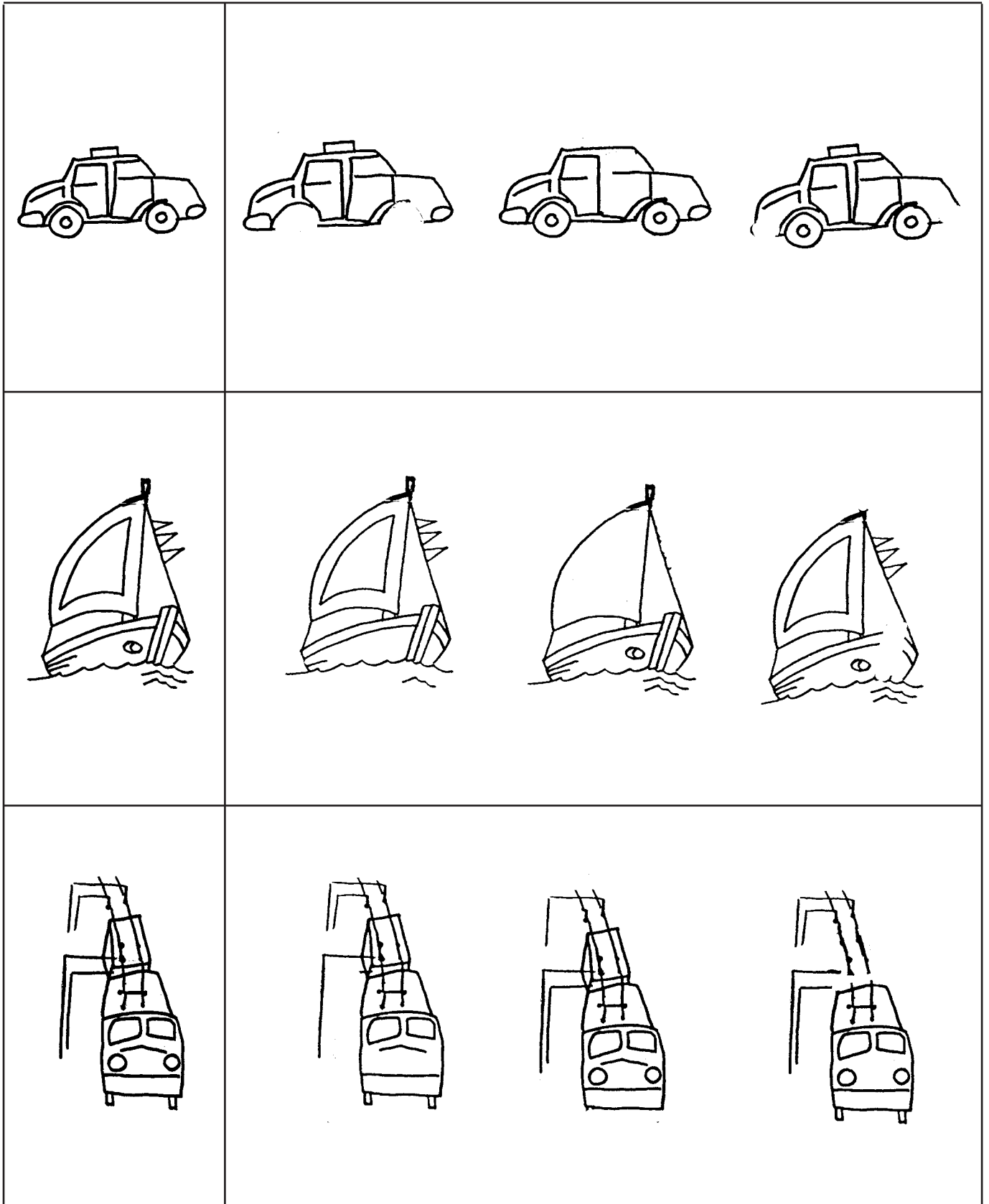



Completa las figuras:

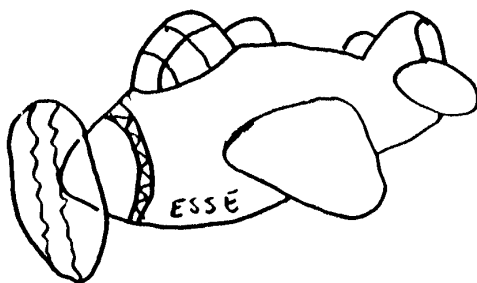
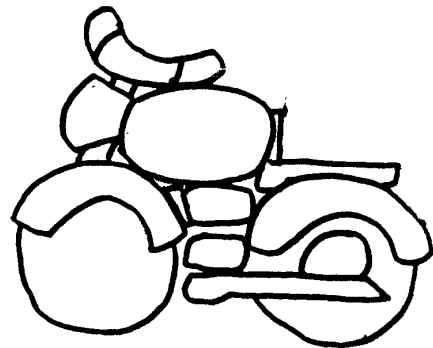
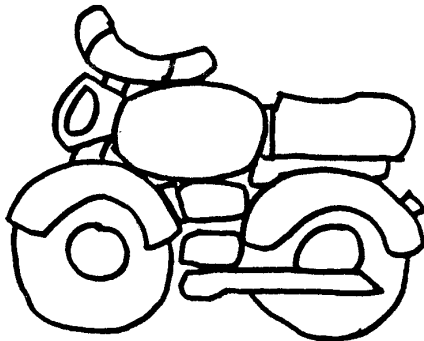
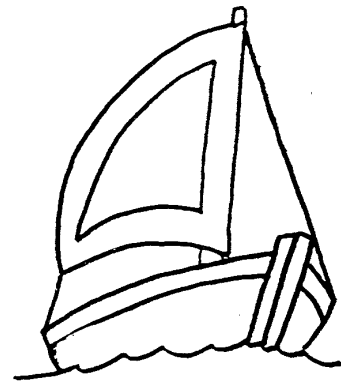
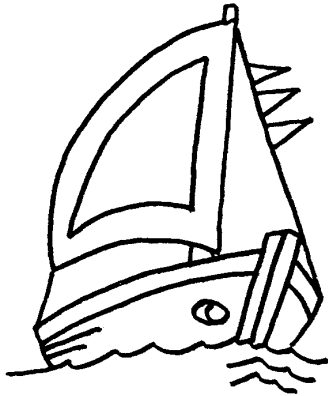

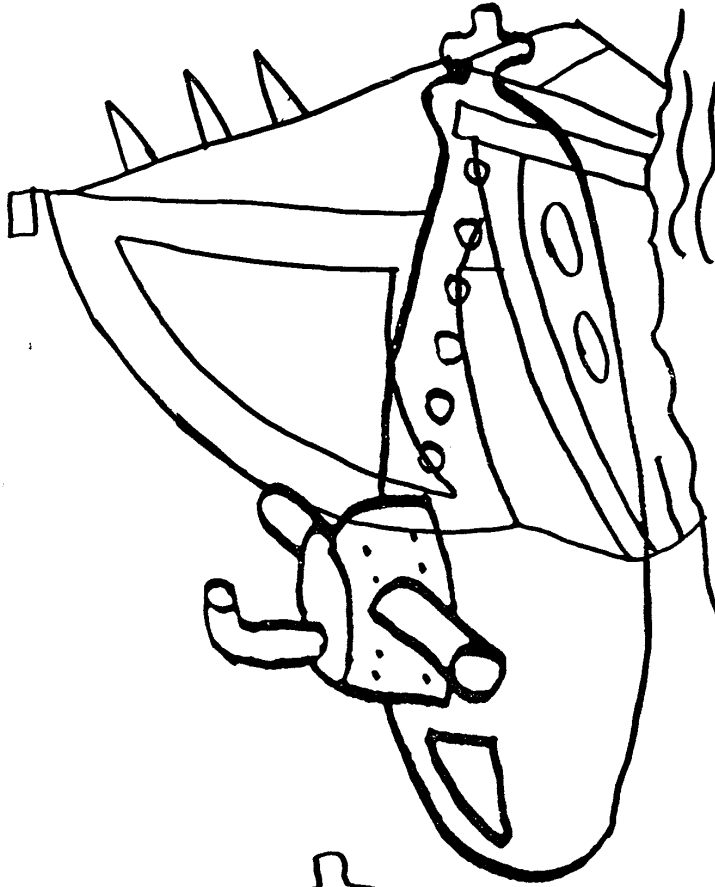

el barco

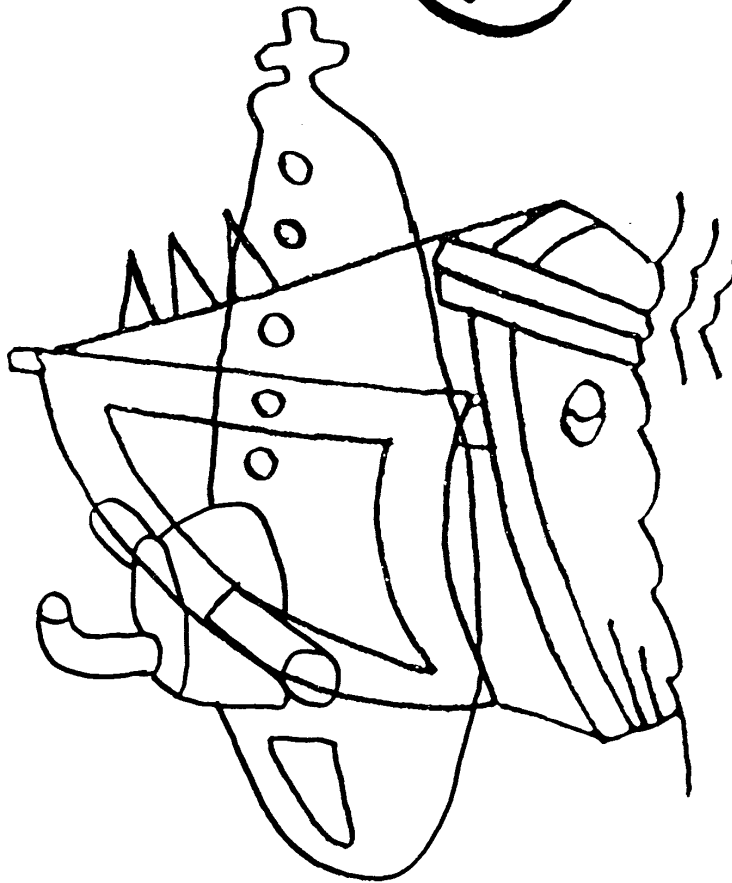

el submarino

Colorea:



Recorta y pega en el siguiente folio las viñetas ordenadas:

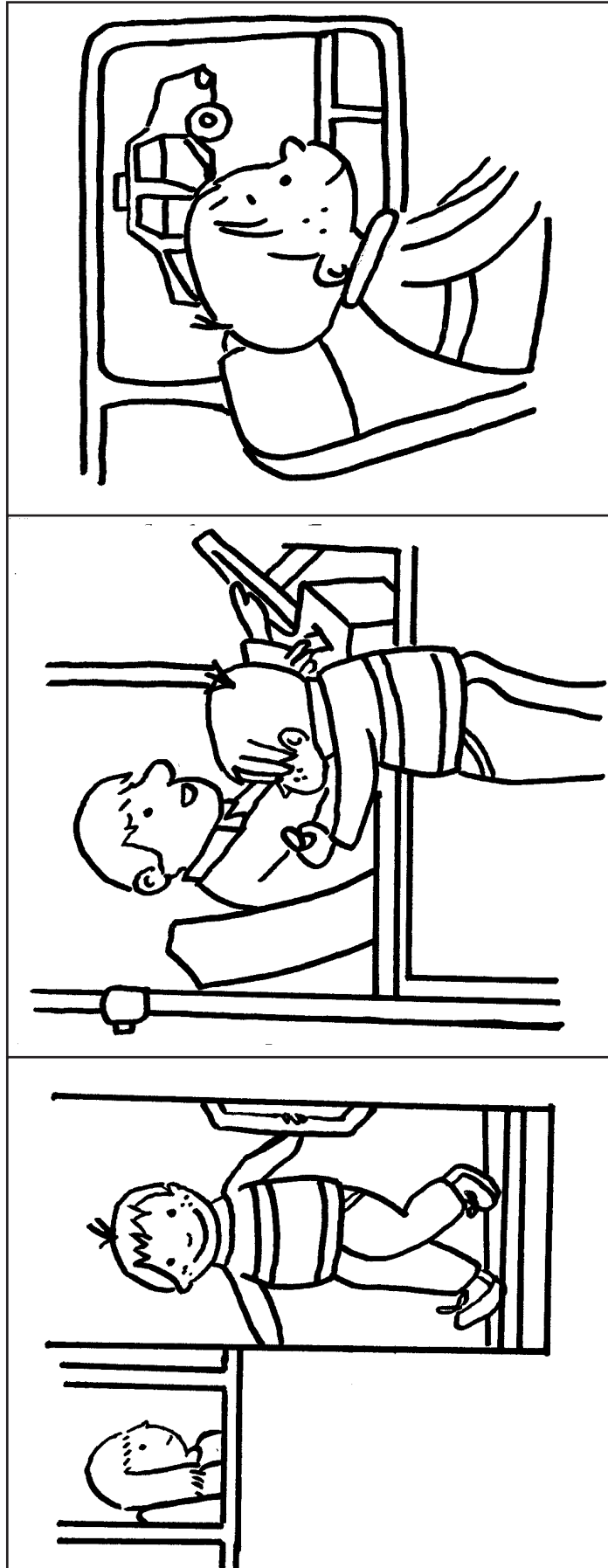



Pega ordenadamente las viñetas:



Laberinto:

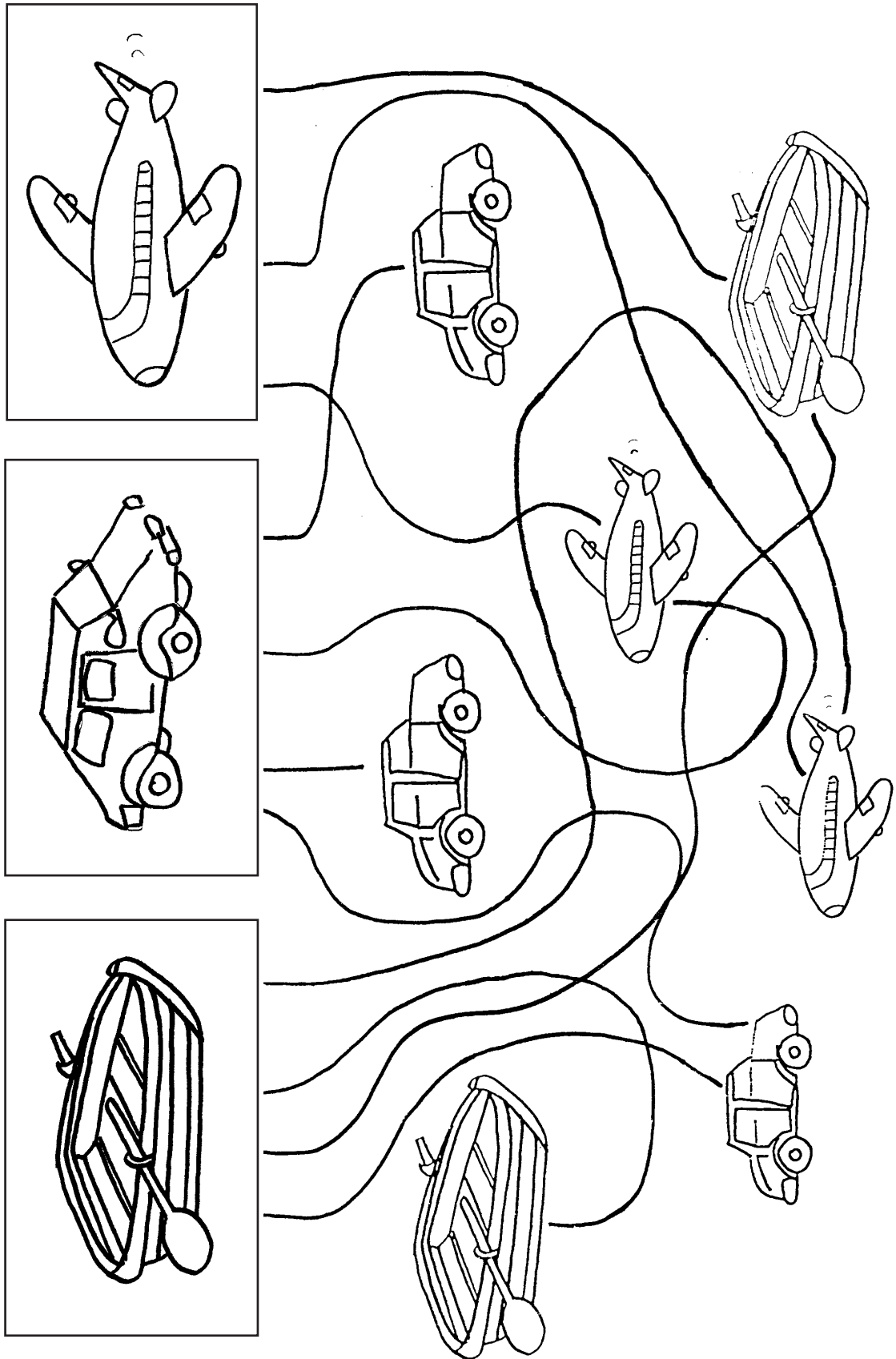



Rompecabezas:

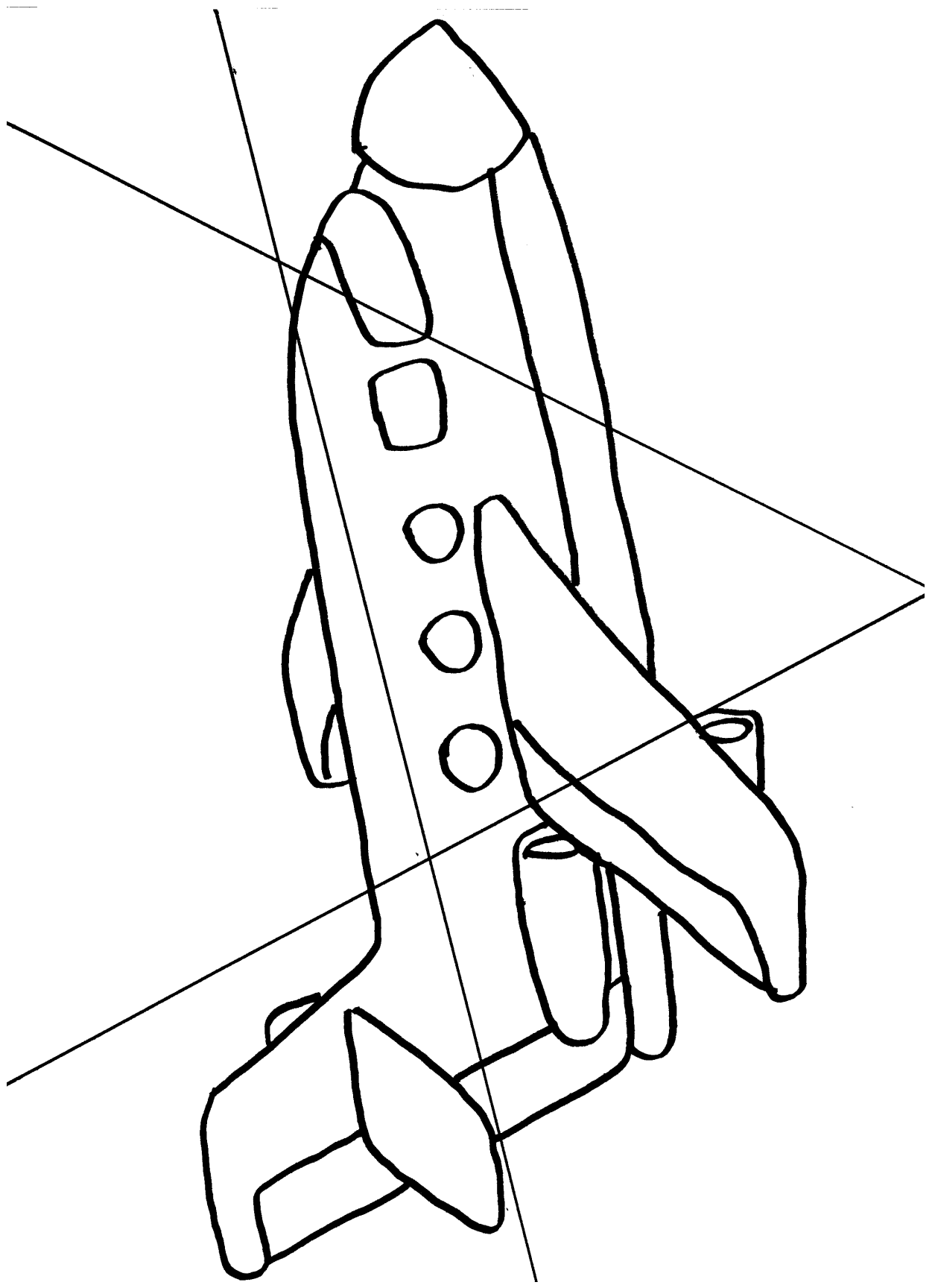



Tacha las acciones erróneas y colorea las acciones correctas:

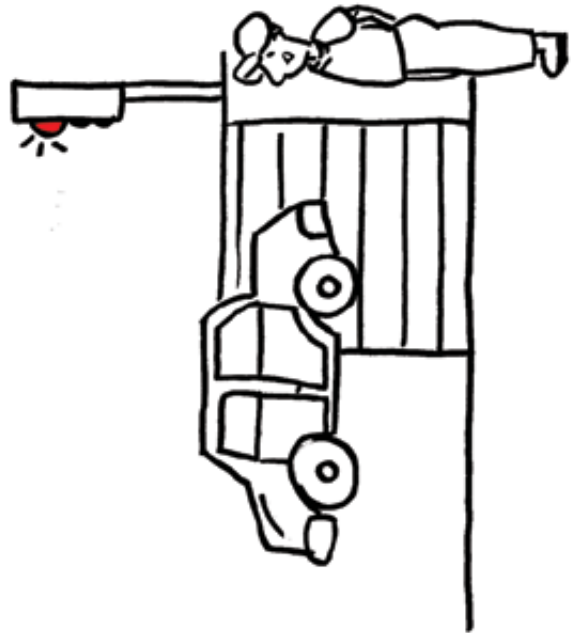
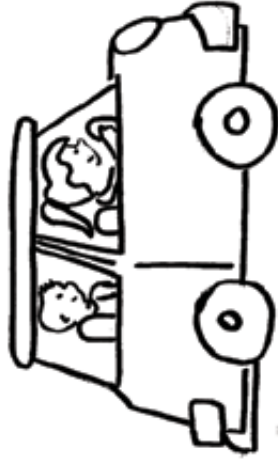



Recorta y une las dos mitades correspondientes

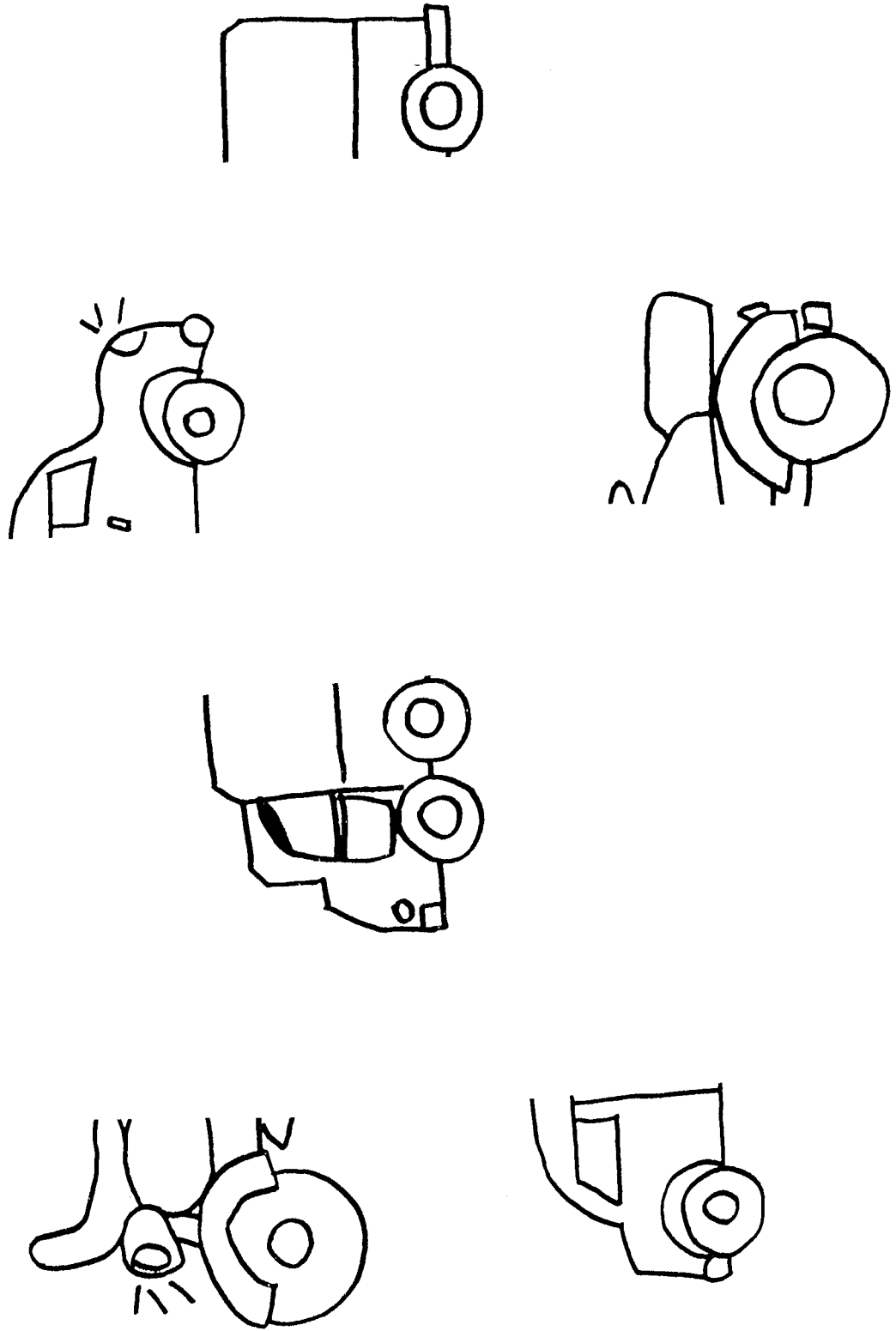



Colorea en rojo los medios de transporte rápidos y en azul los lentos:

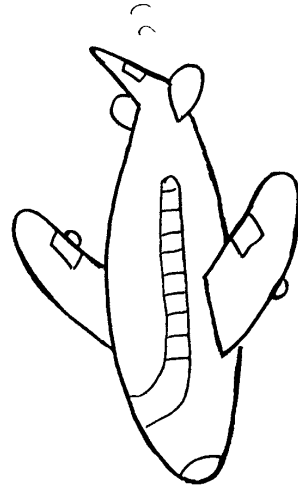
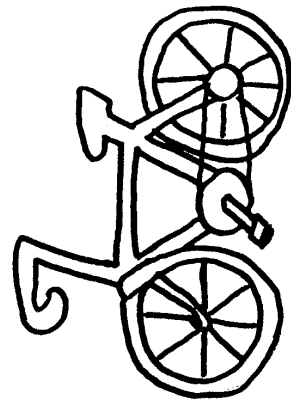
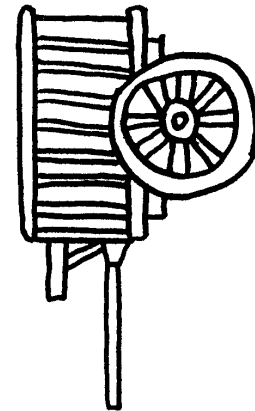
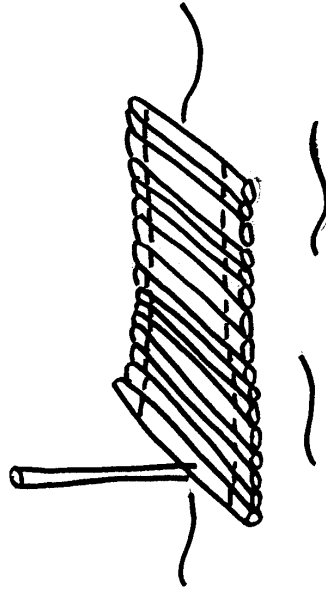
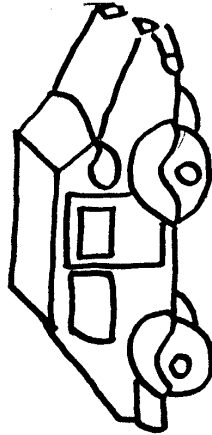
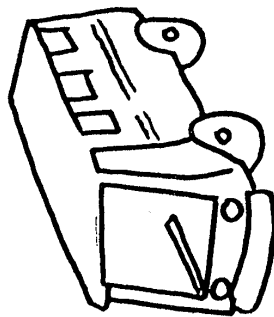



Colorea el conjunto donde hay un par de medios de transporte:

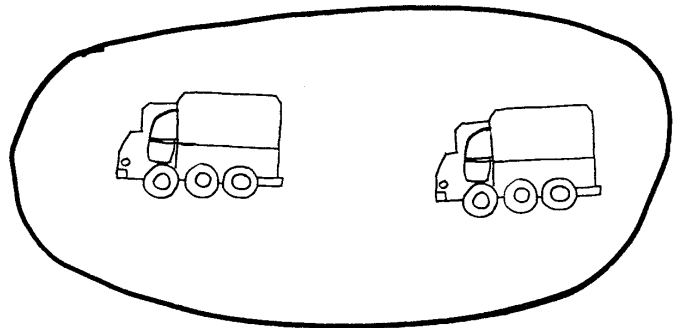
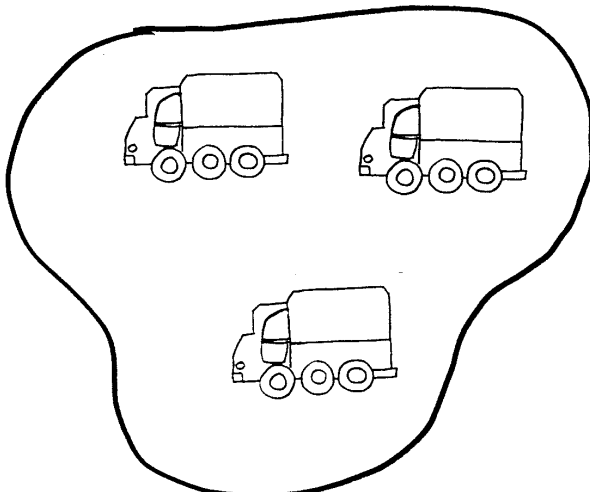
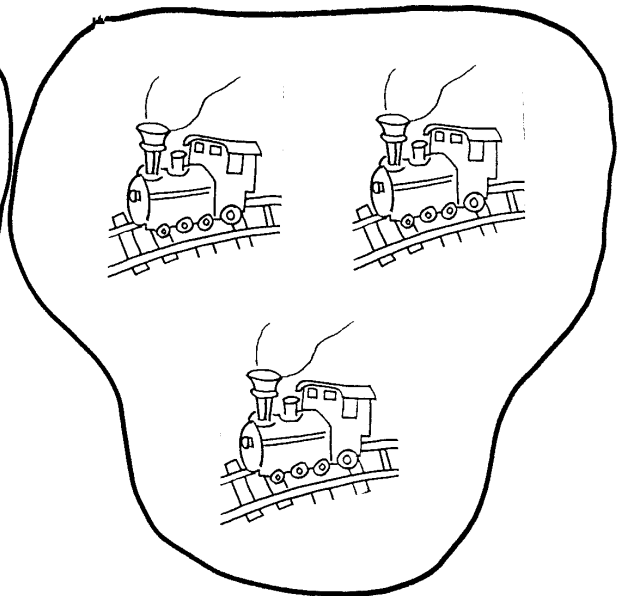
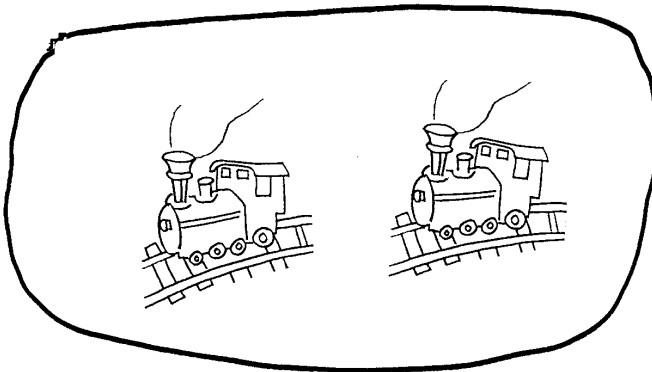
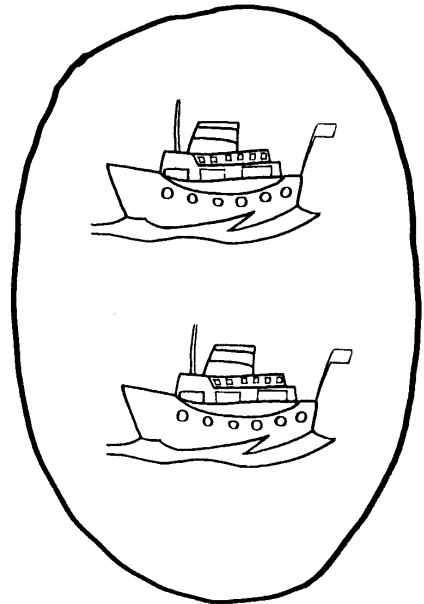
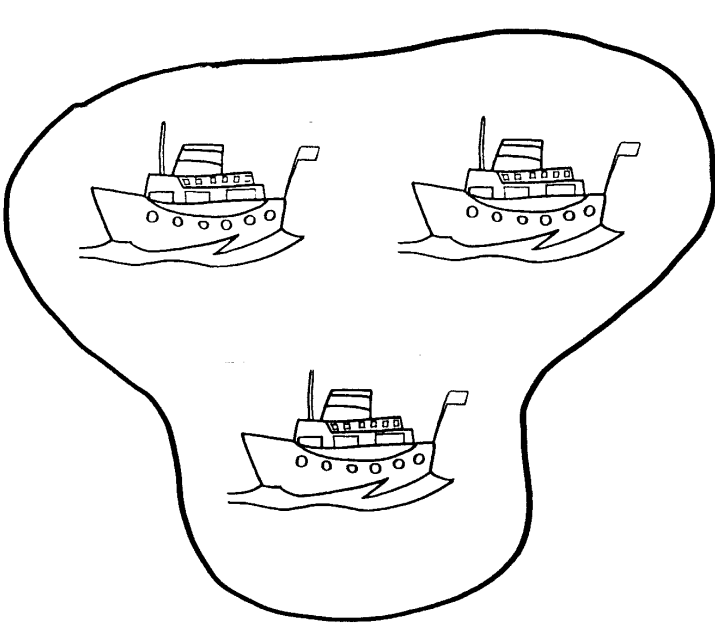

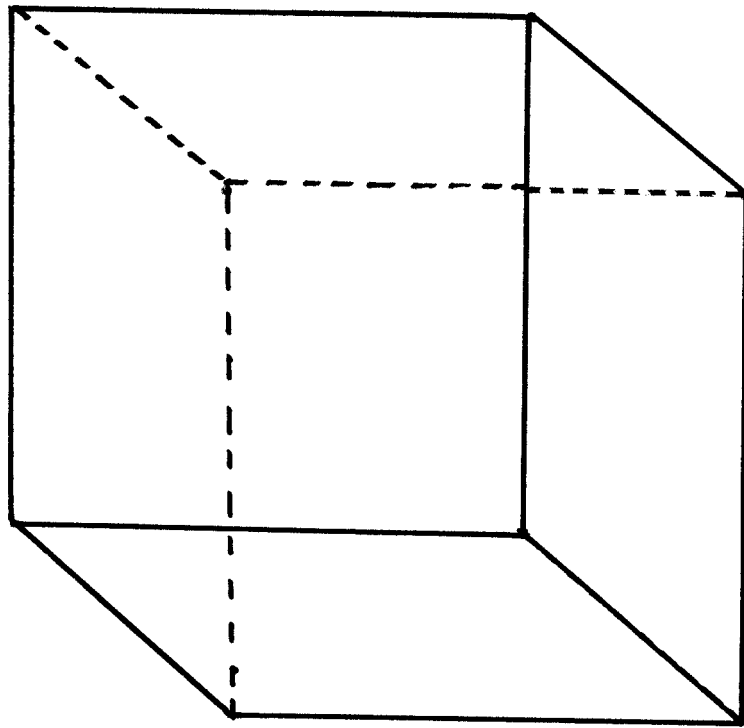

cube

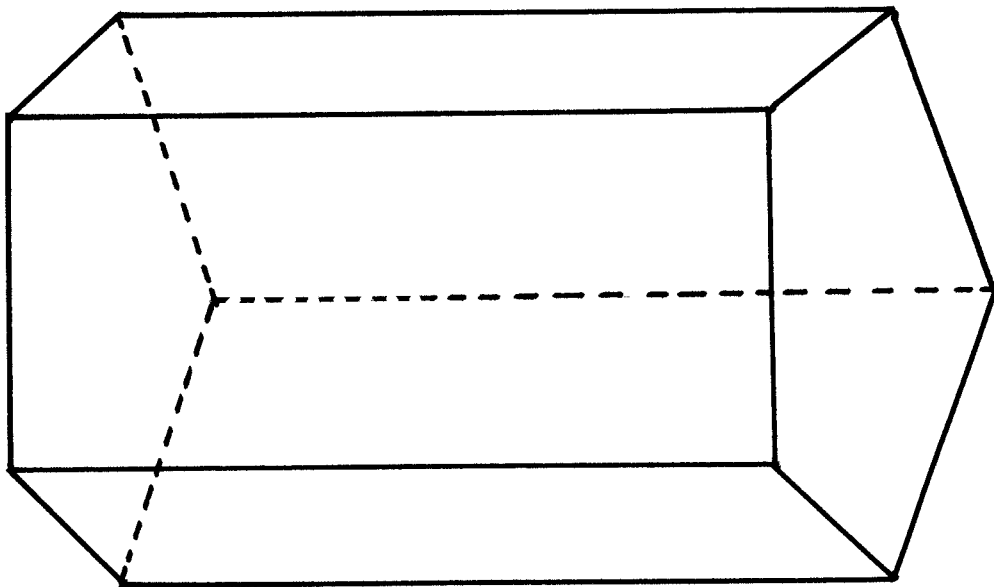

Prisma

Cuerpos geométricos:



Cuerpos geométricos:

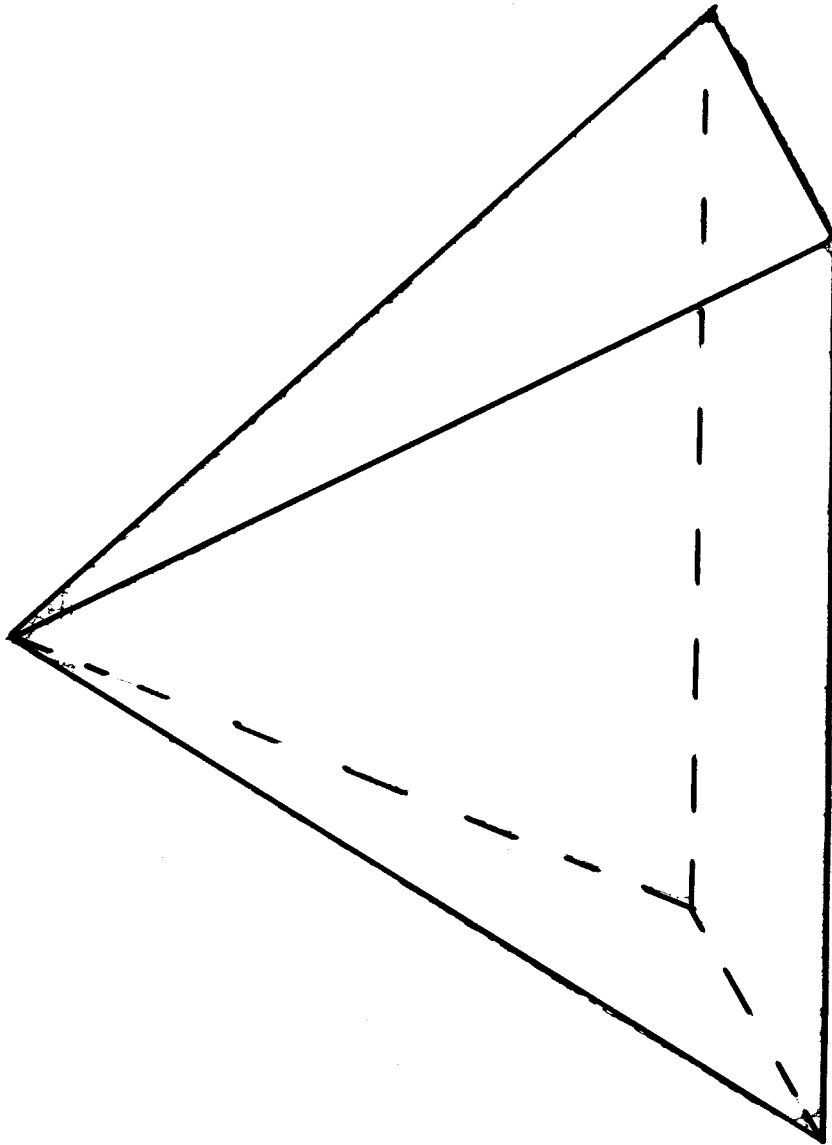

pirámide



Colorea, recorta y construye el prisma:

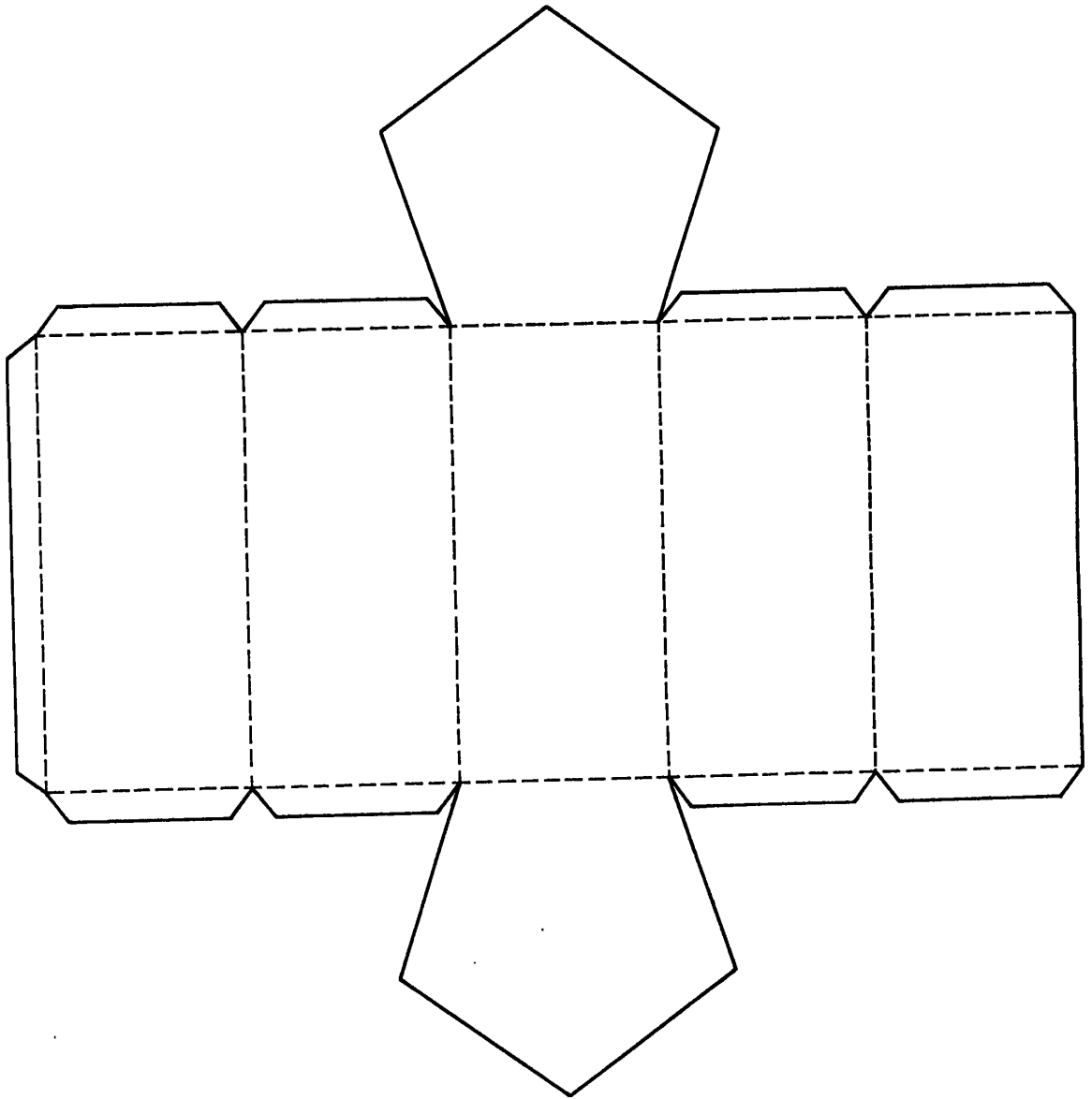



Colorea, recorta y construye el cubo:

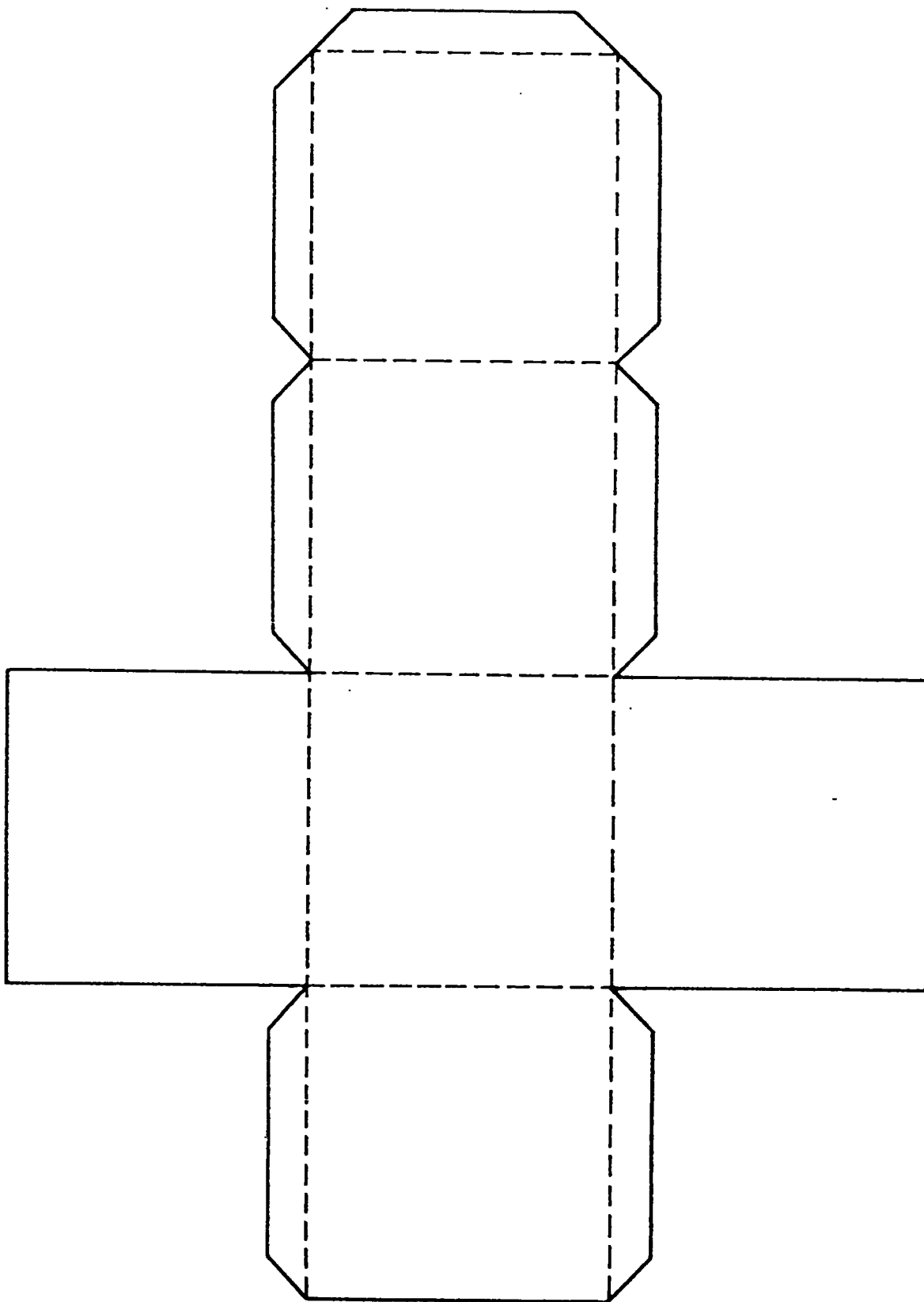



Colorea, recorta y construye la pirámide:

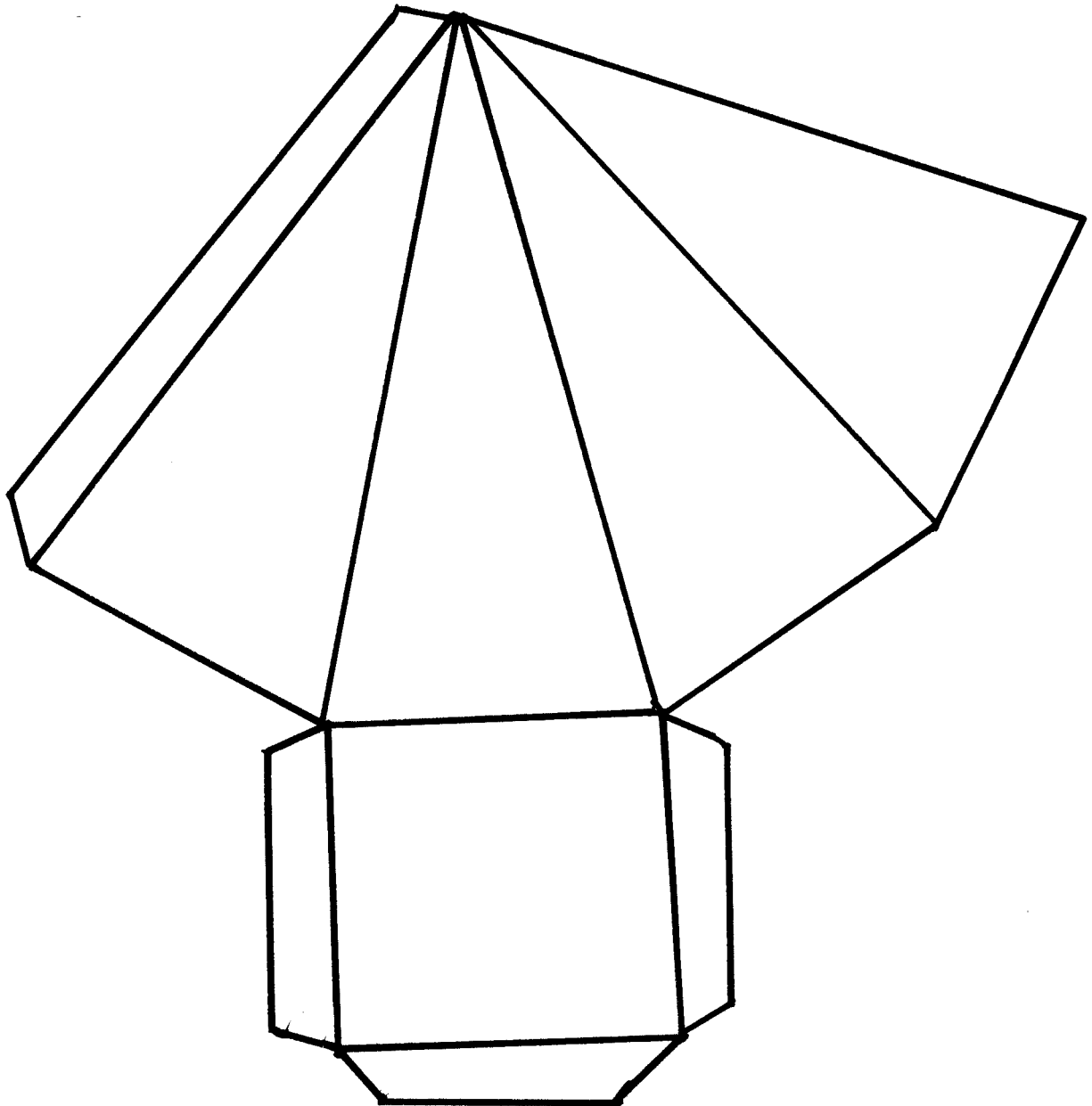



Colorea, recorta y pega estos medios de transporte en la siguiente lámina:

